



PACKTALK BOLD

EN POCKET GUIDE



OPERATED BY
NATURAL VOICE



POWERED BY
DMC

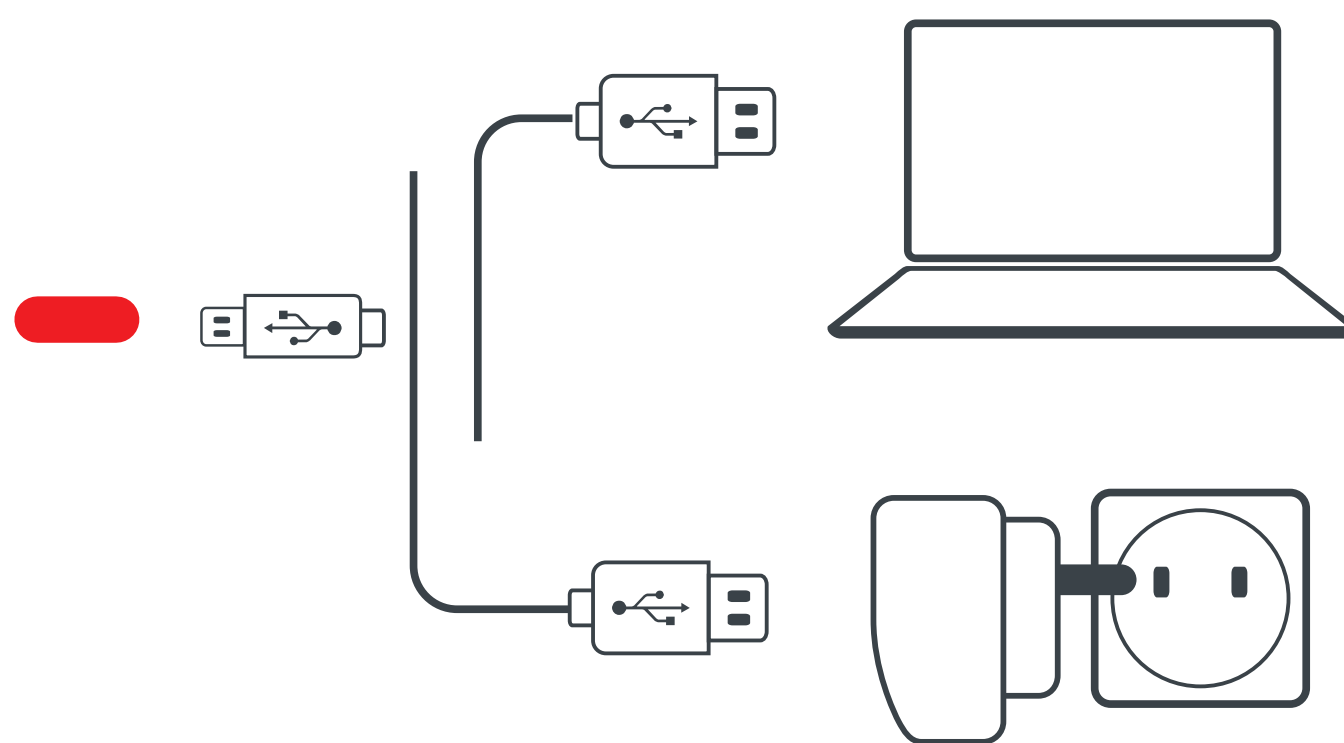
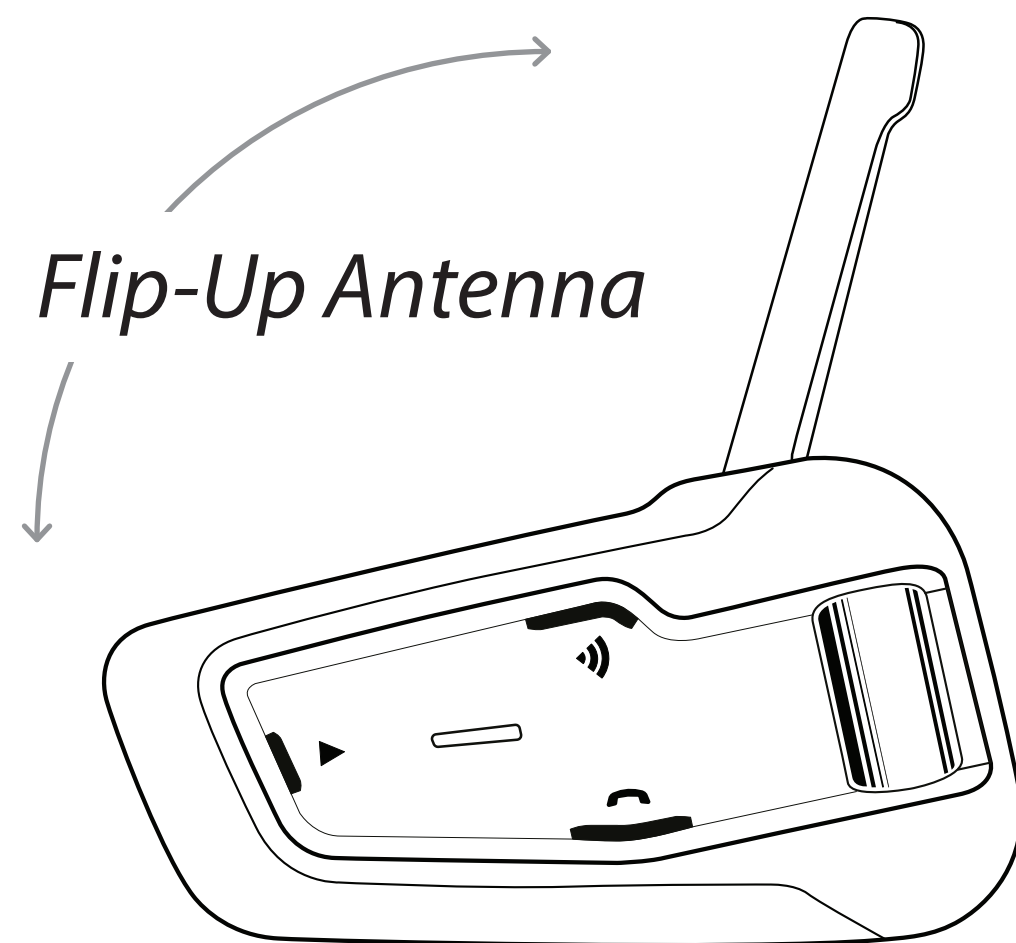
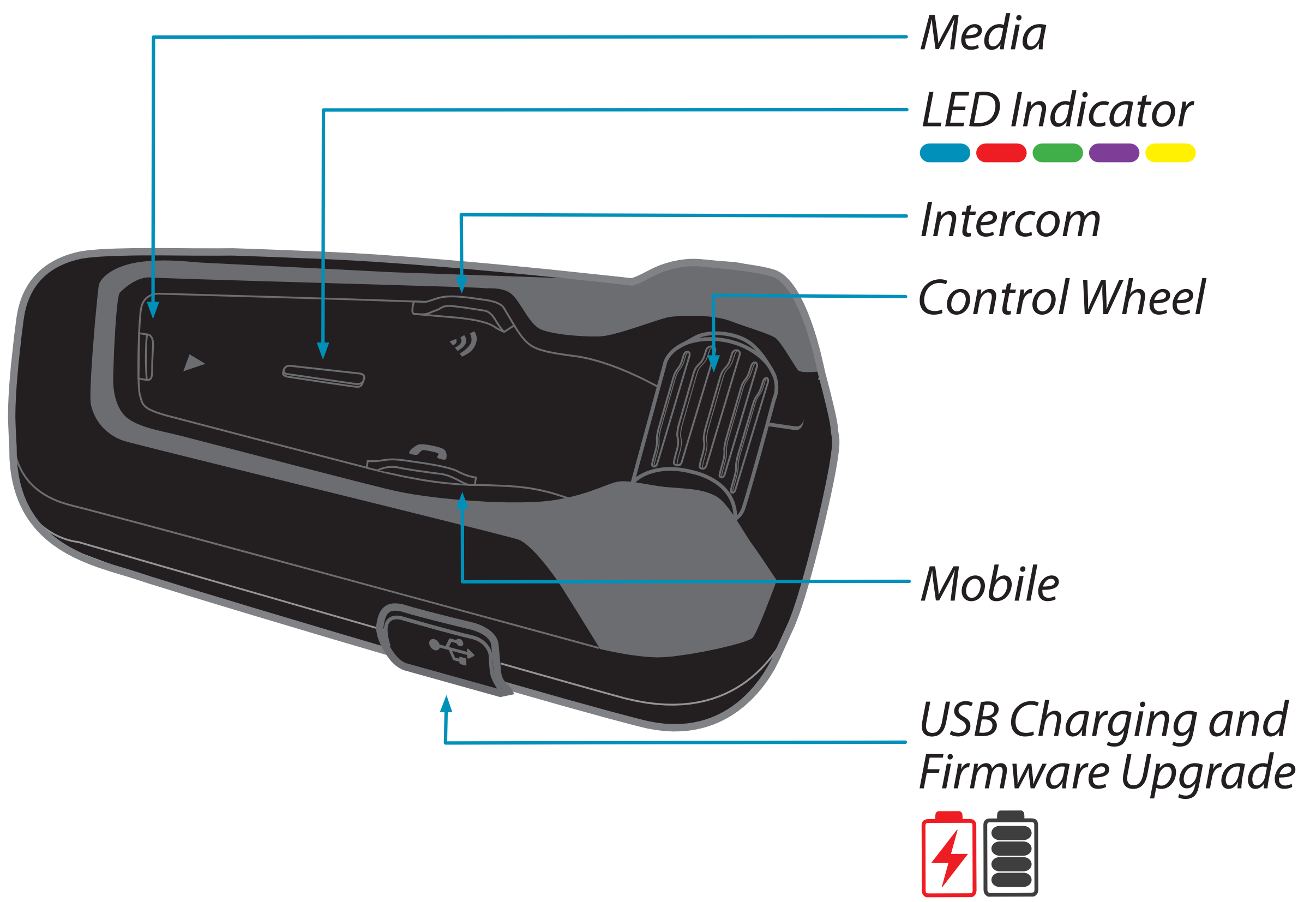

"Language can be changed via the Cardo Connect mobile app"

Getting Started



On / Off

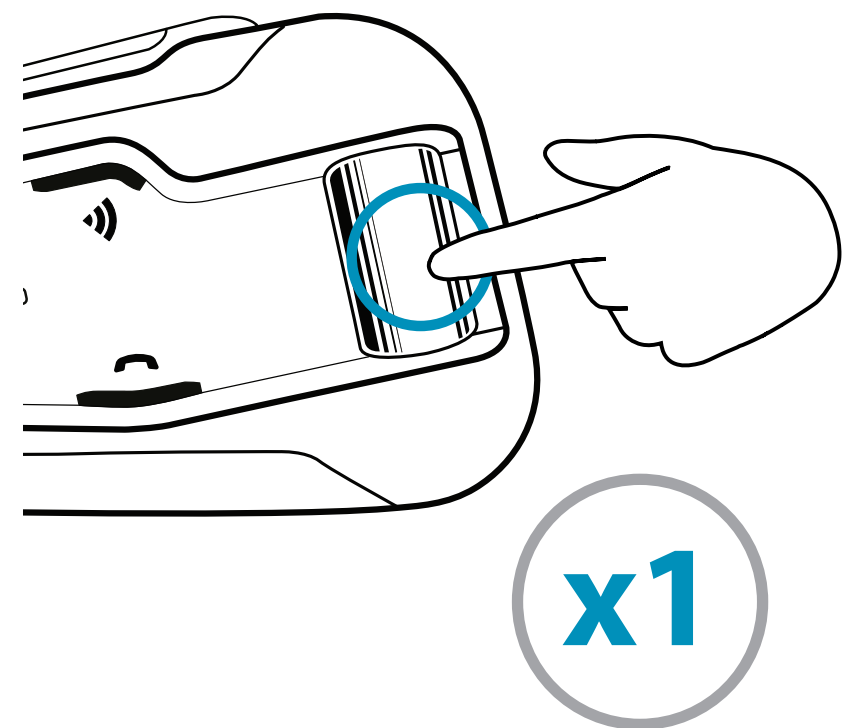
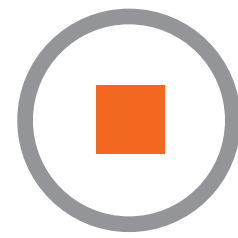
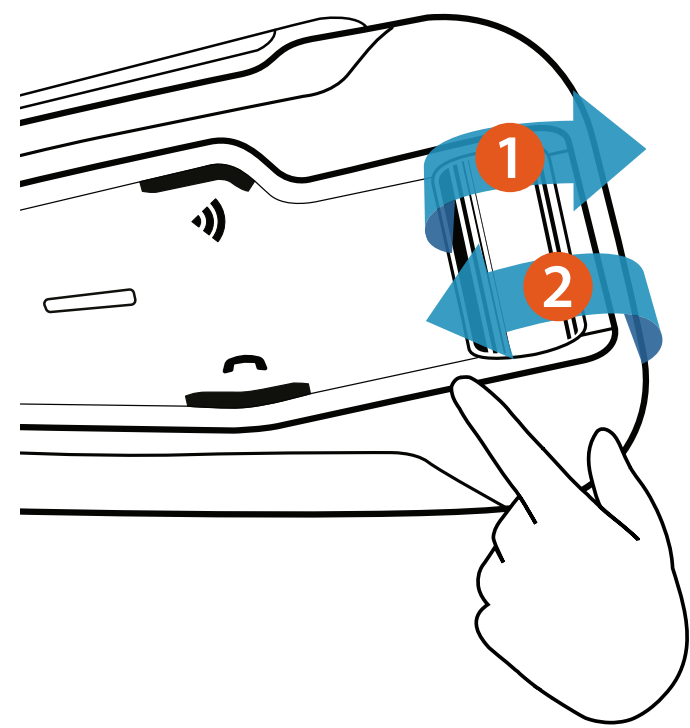
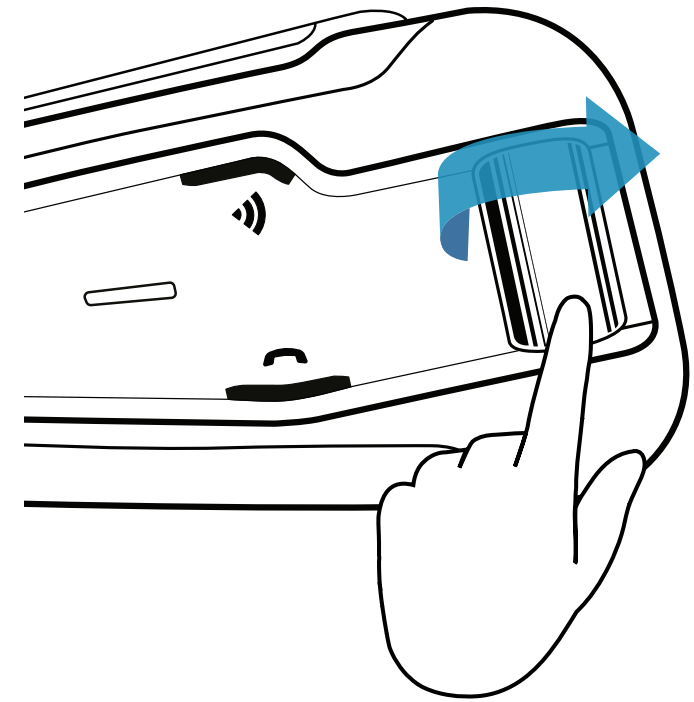
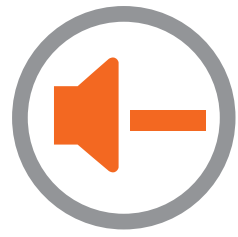
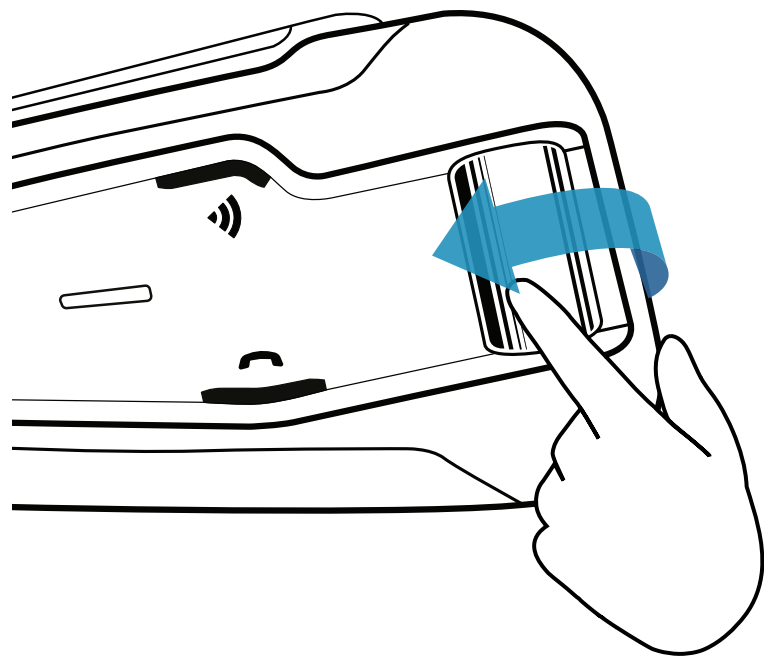
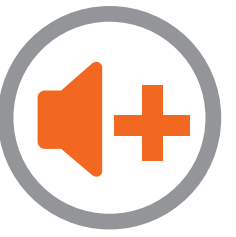
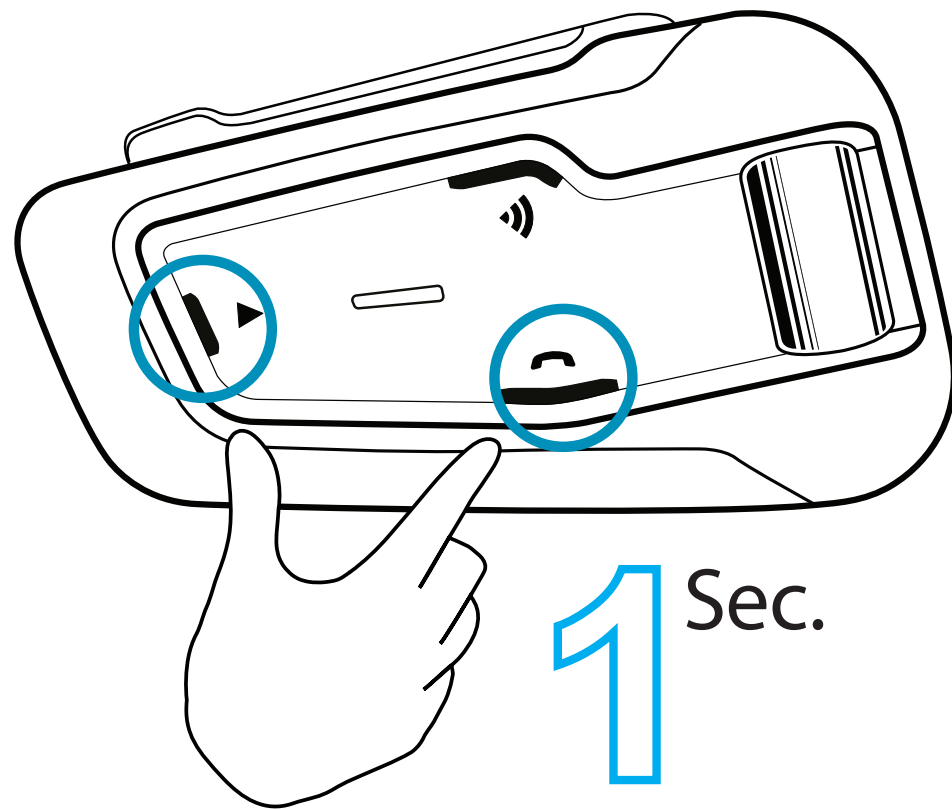

Use while charging

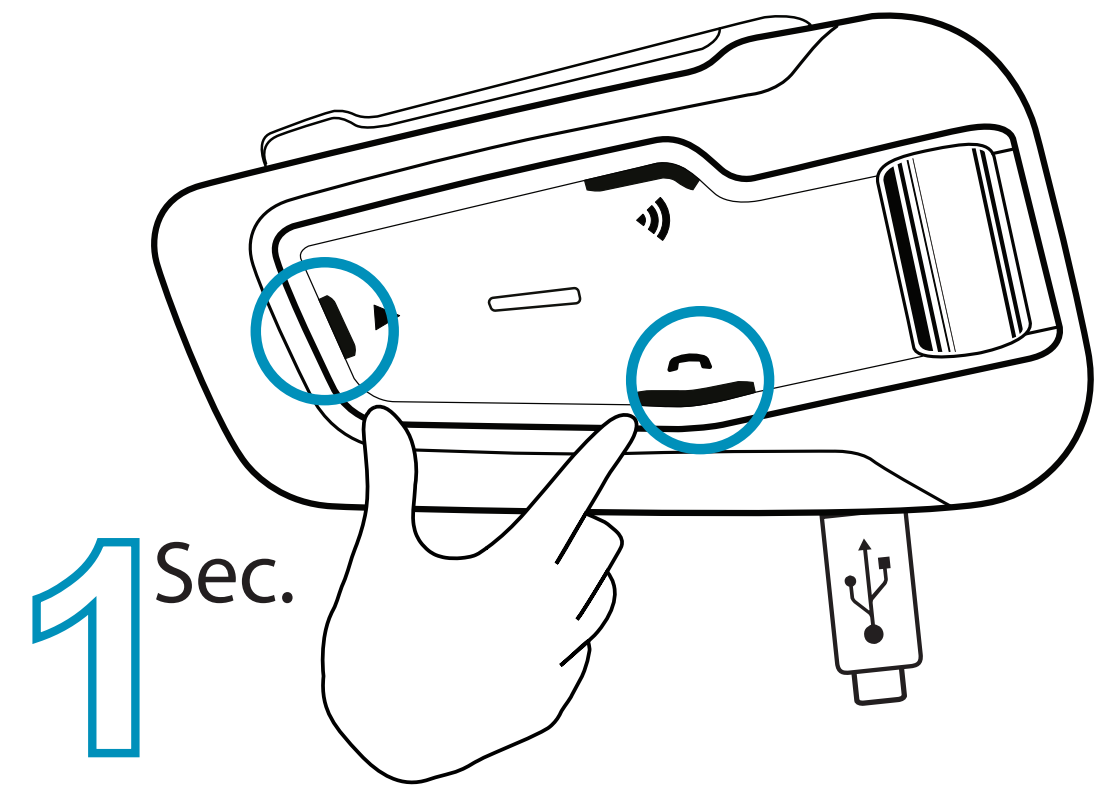
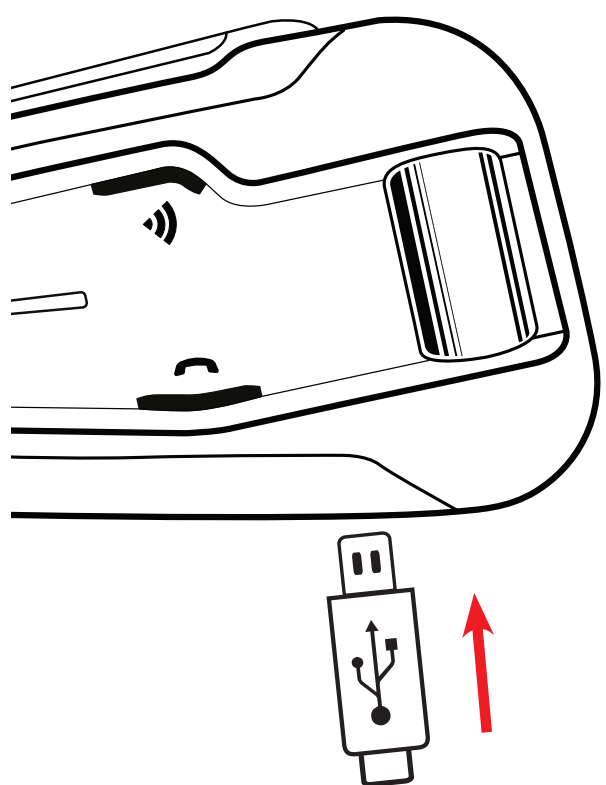

Pair Mobile Devices

1 Initiate Pairing

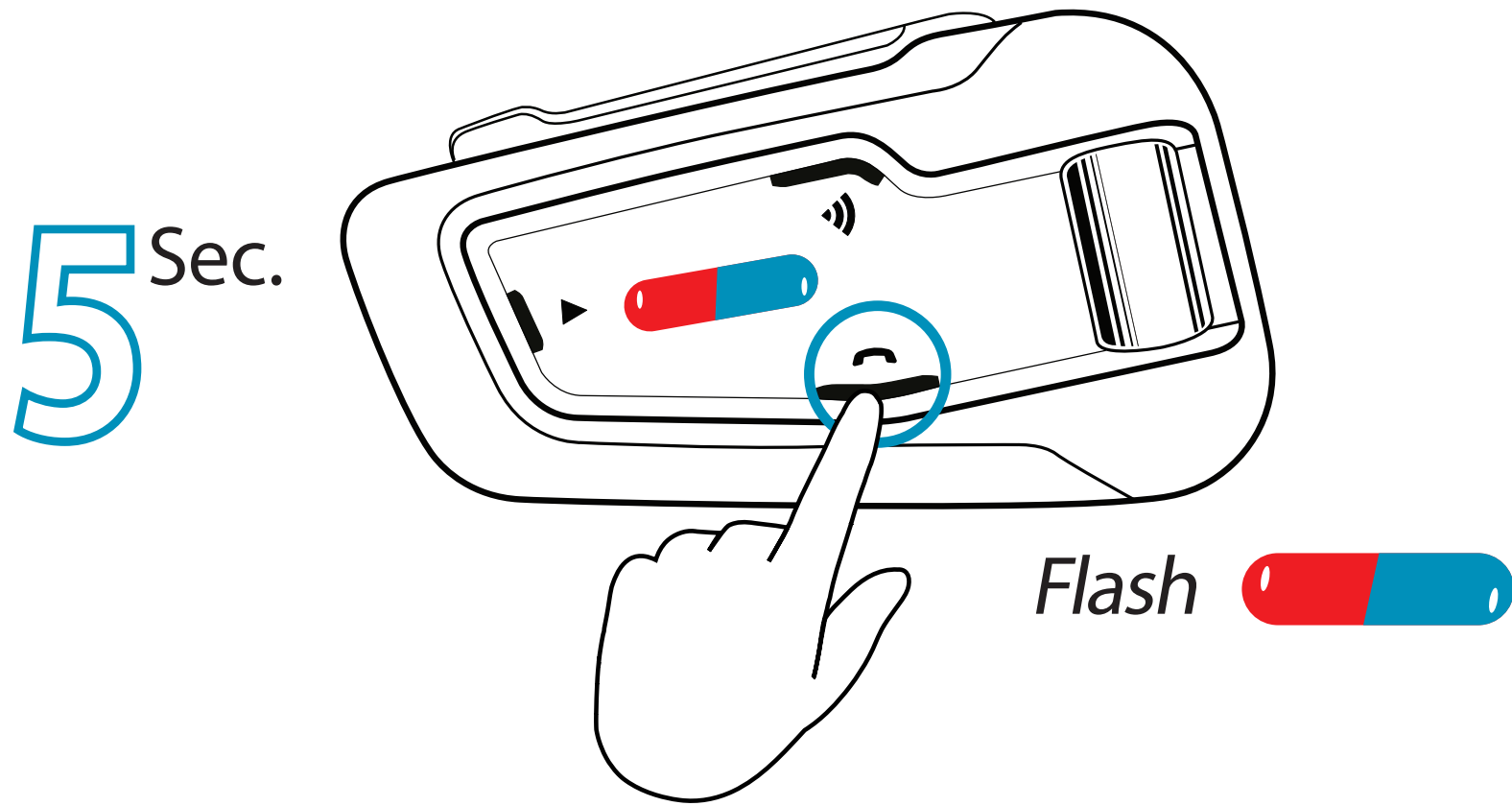

2 Pair Phone

Search for
Bluetooth
devices



Cancel Pairing

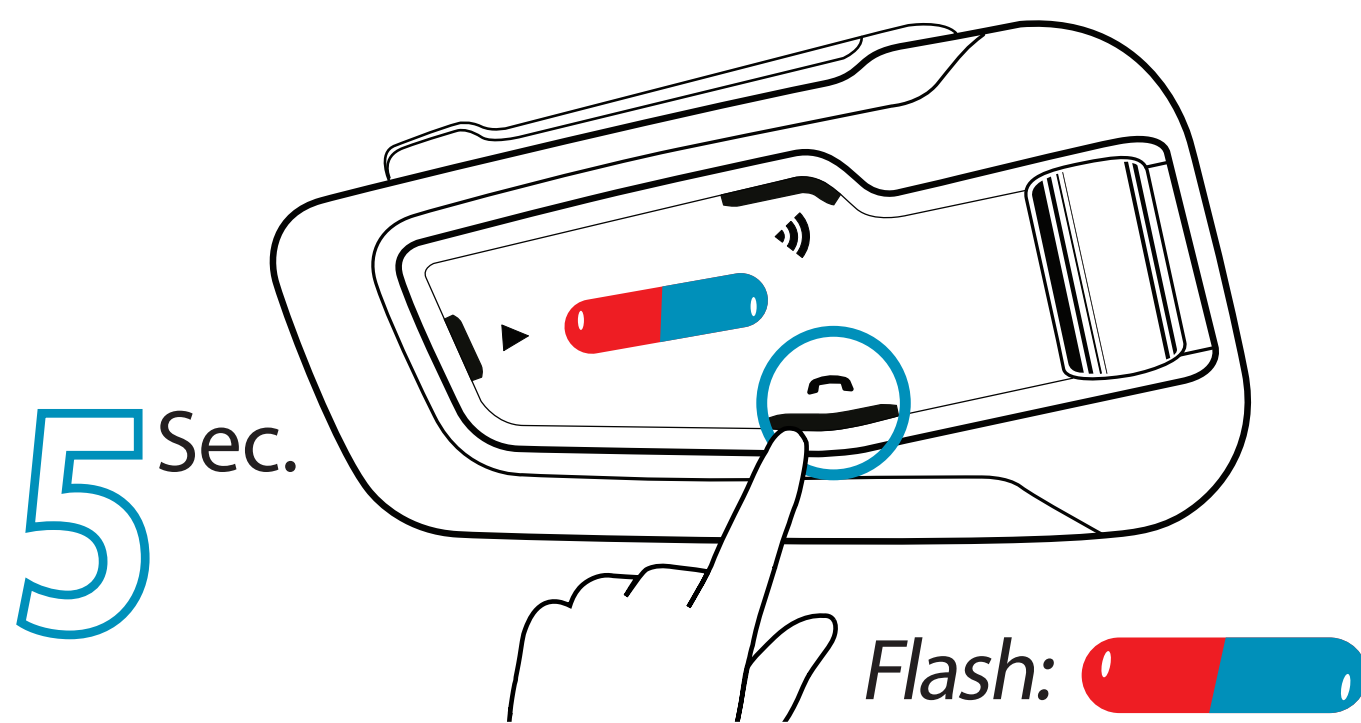

END

Paired successfully

Flash

Pair Mobile Devices

1 Initiate Pairing

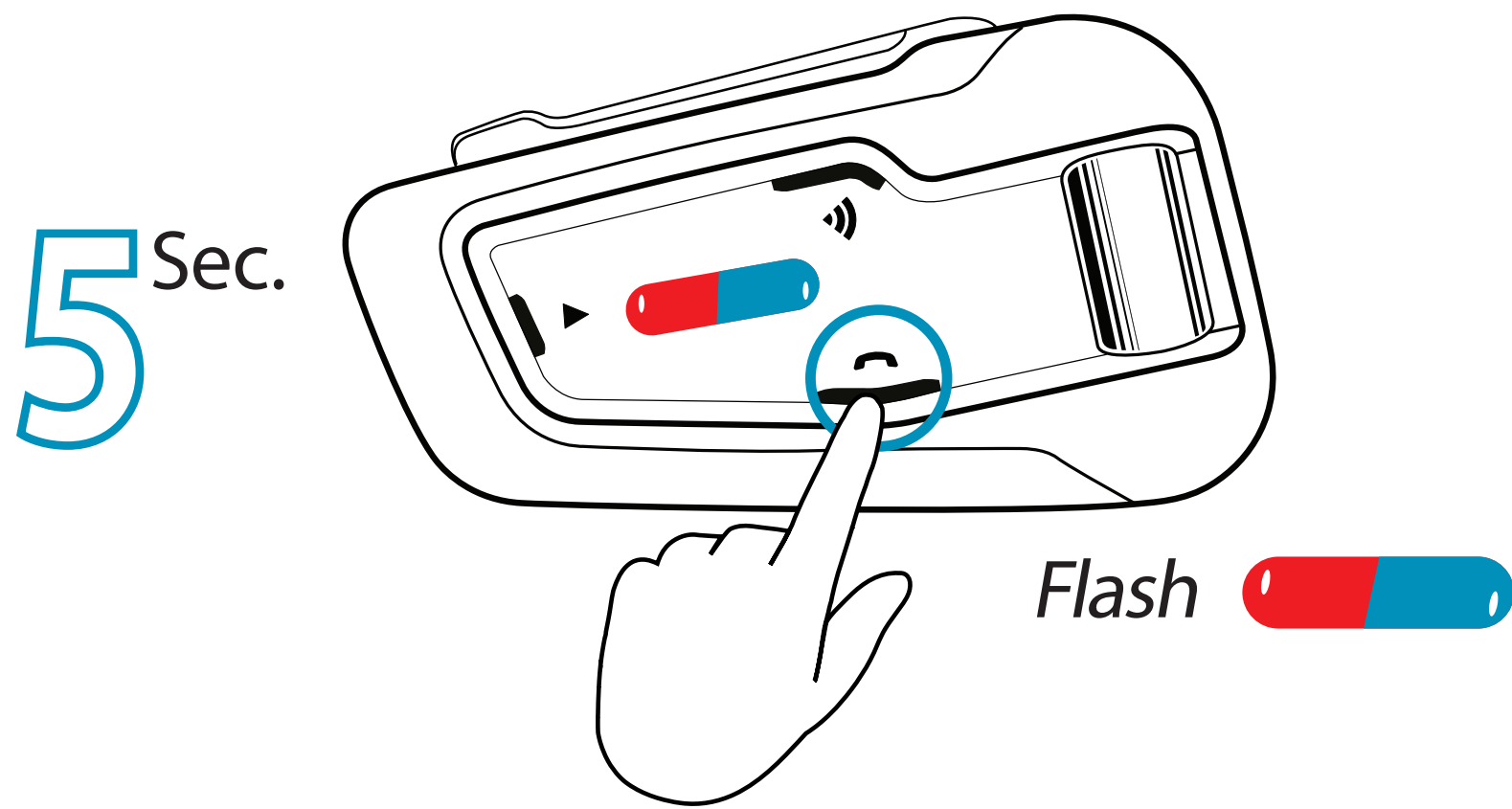

2 Add a 2nd Phone / GPS

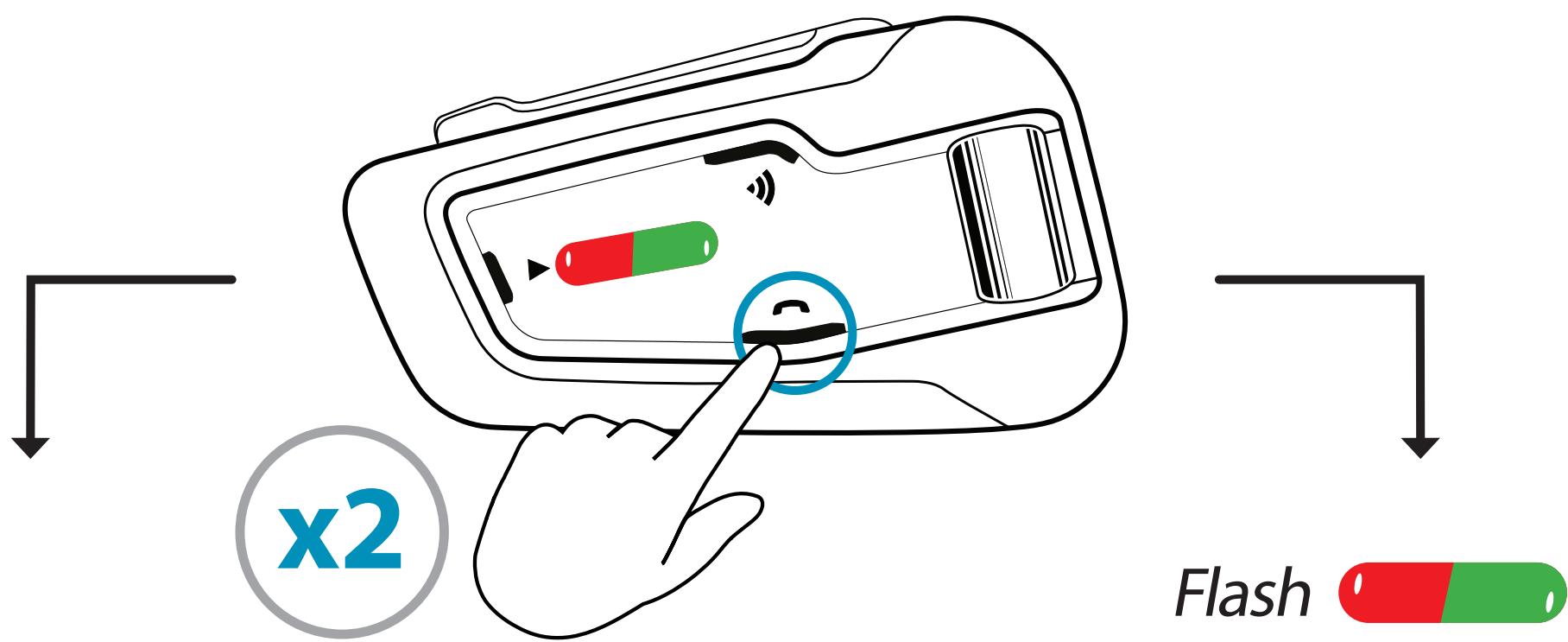

3 Pair Phone

Search for Bluetooth devices

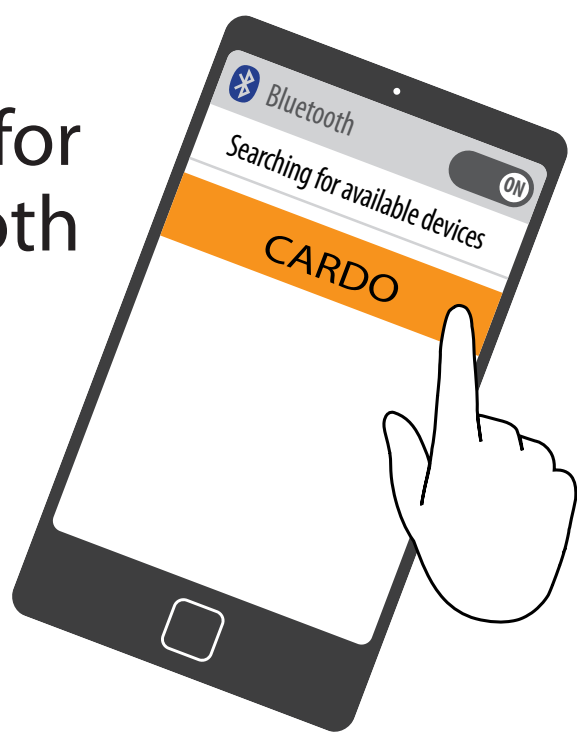

3 Pair GPS

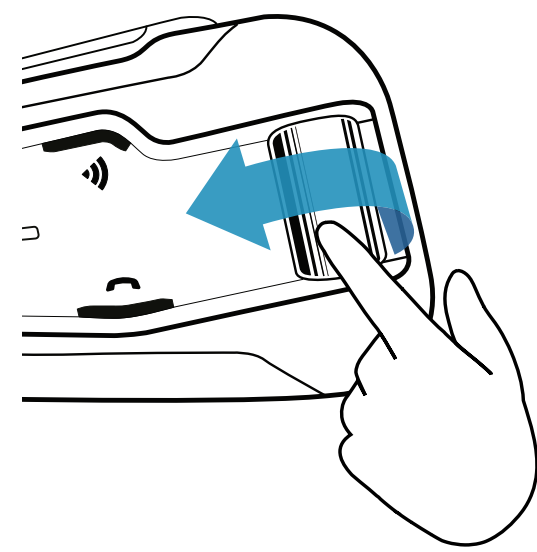

3a

Search for Bluetooth devices on the GPS



END

Paired successfully

Flash



Phone



Voice Dial

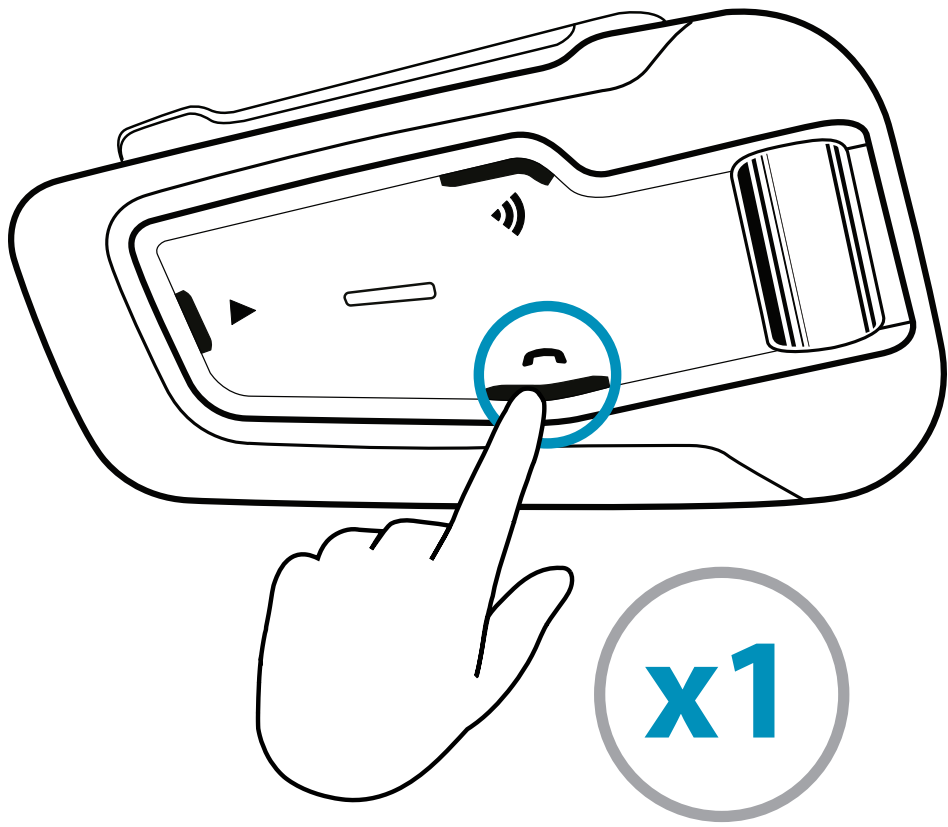

Redial

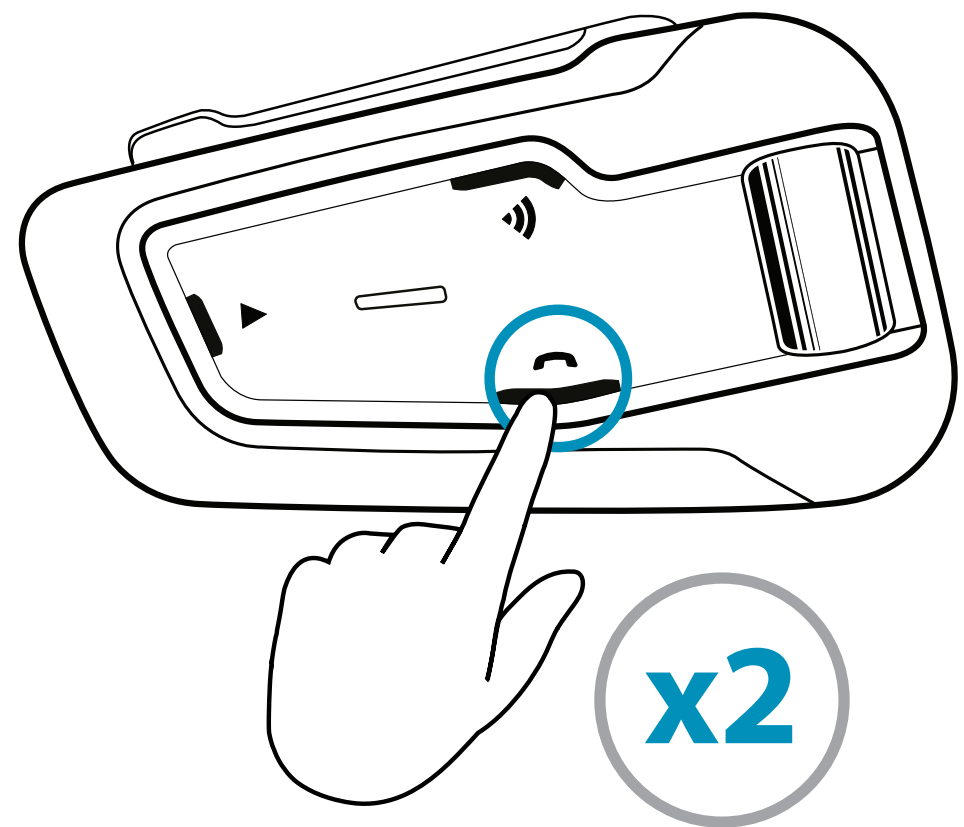

Speed Dial

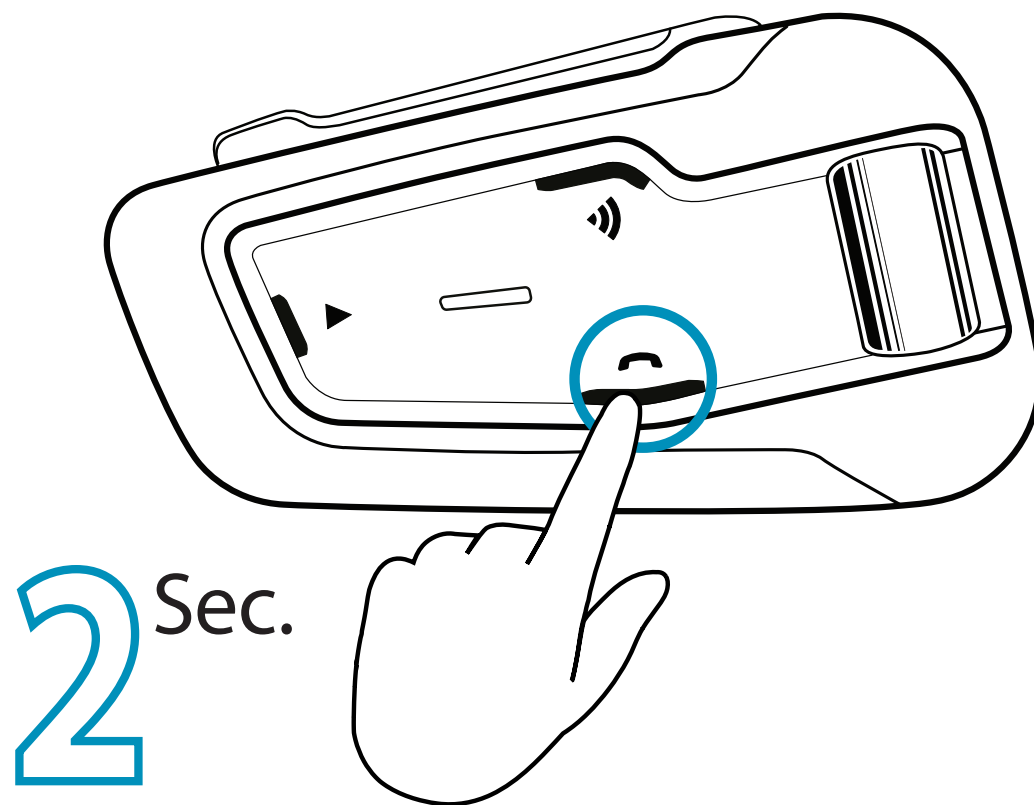

Set via app

Share call with DMC group

Bridging active phone calls to the DMC group

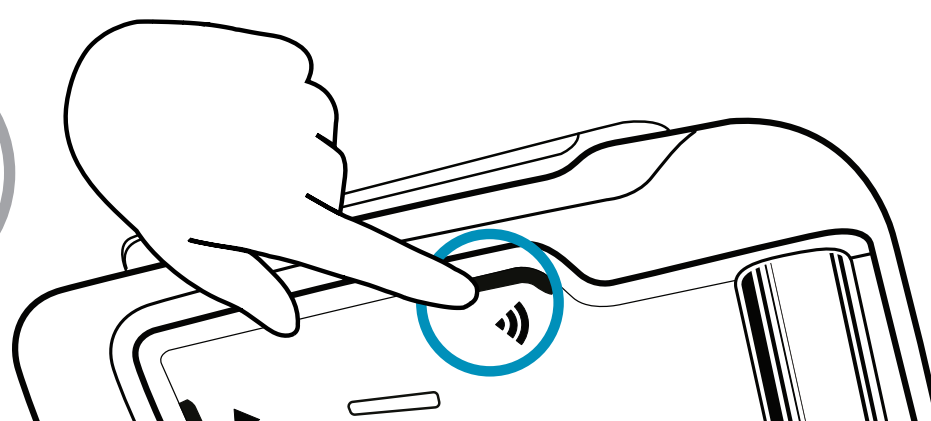

Start / Stop sharing call

Phone



Answer a Call

x1

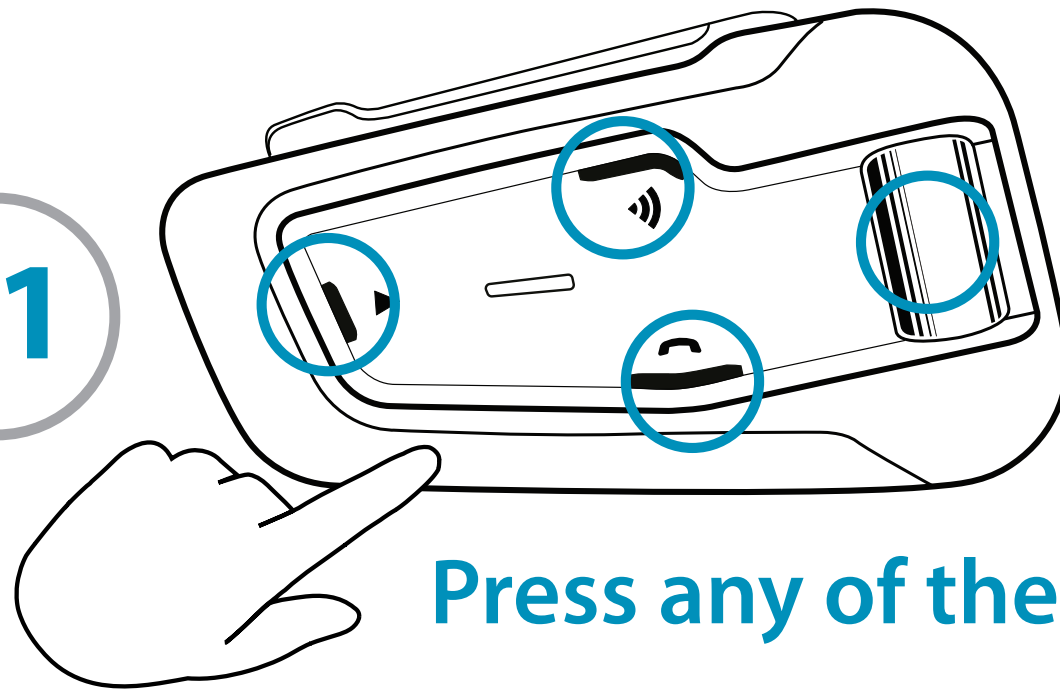

Press any of these buttons



Ignore a Call

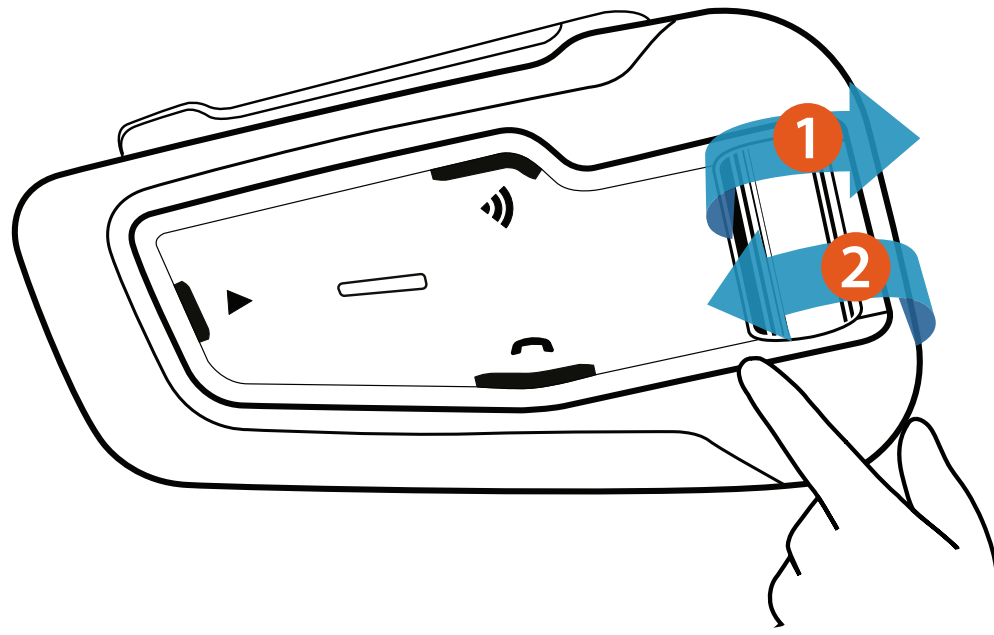

Reject a Call

2 Sec.

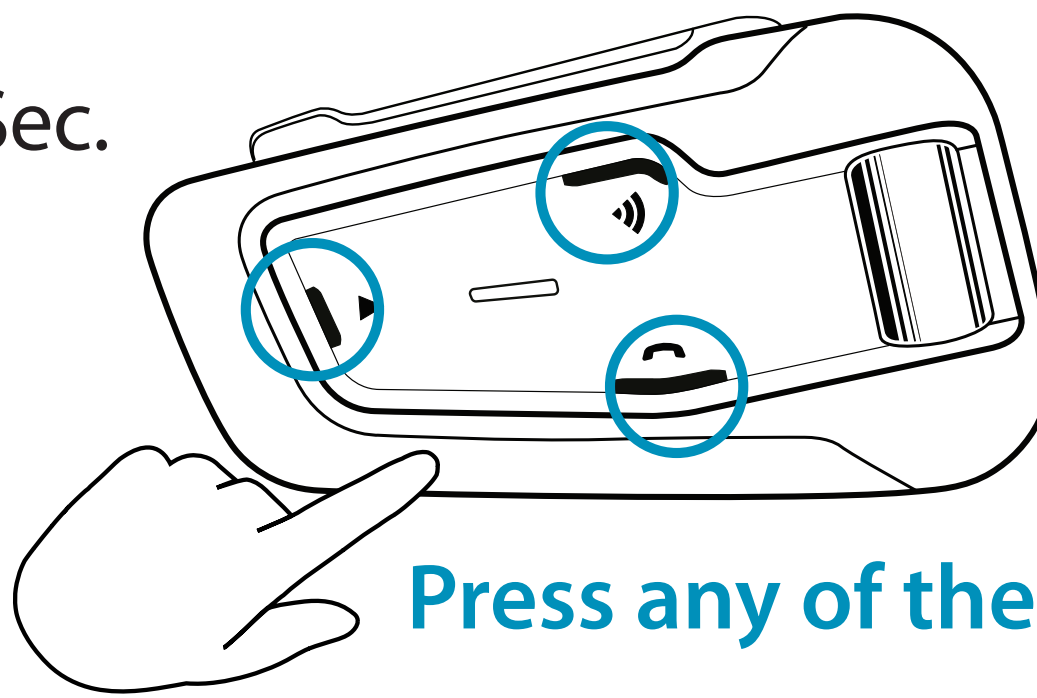

Press any of these 3 buttons



End a Call

x1

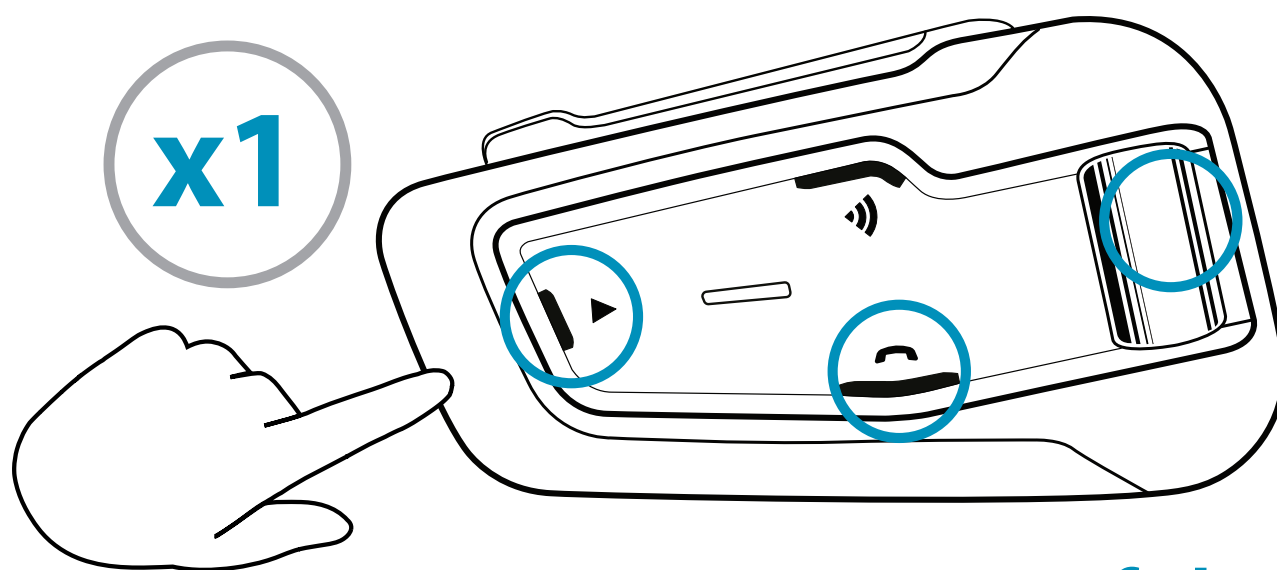

Press any of these 3 buttons

Audio

FM Radio



On

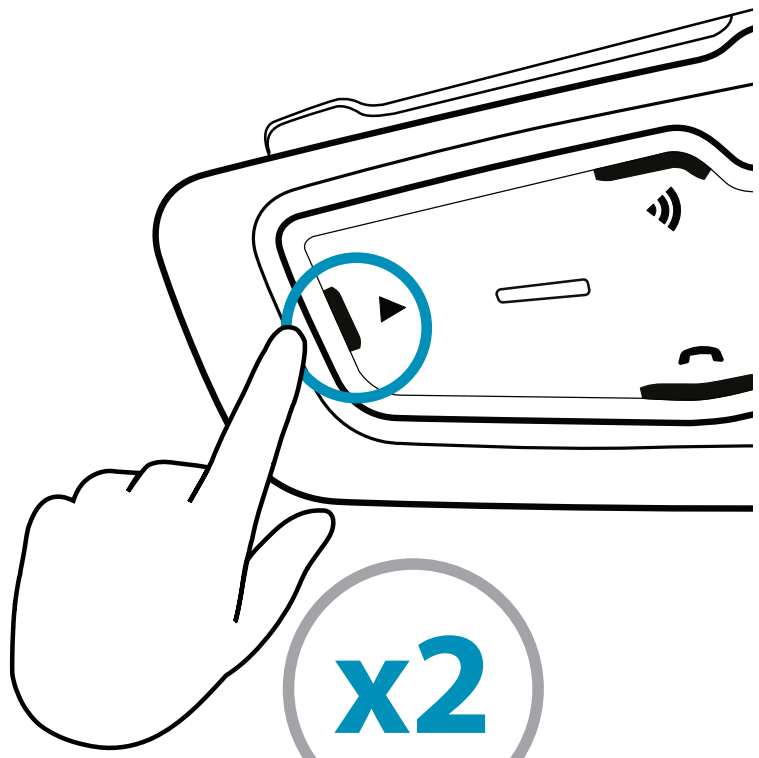

Off

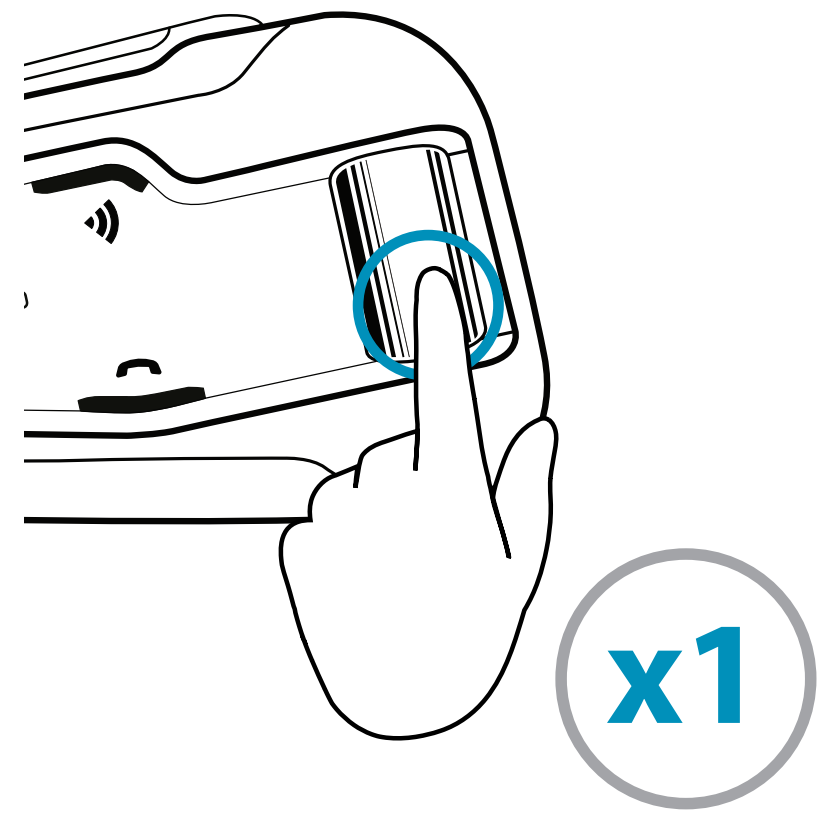

Previous

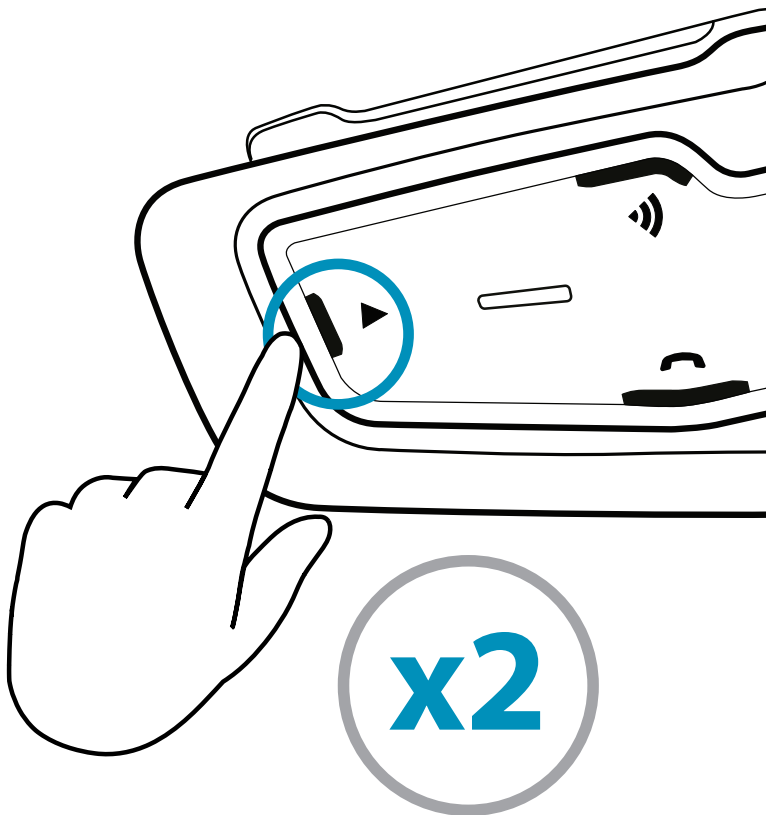

Next

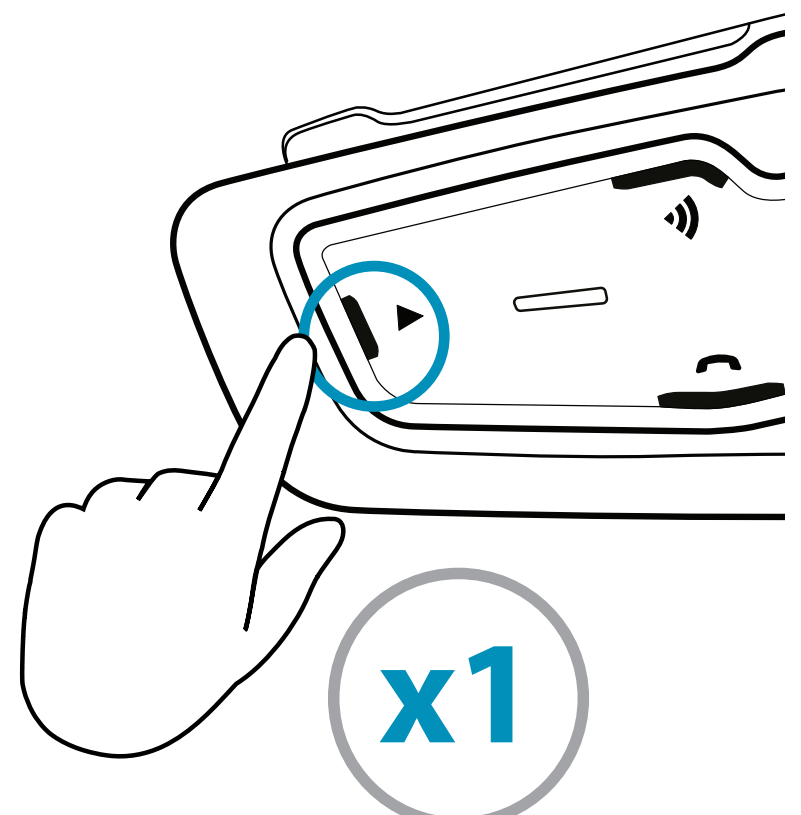

Auto Scan

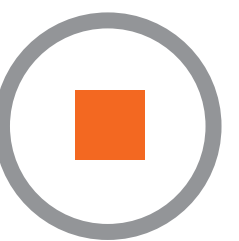
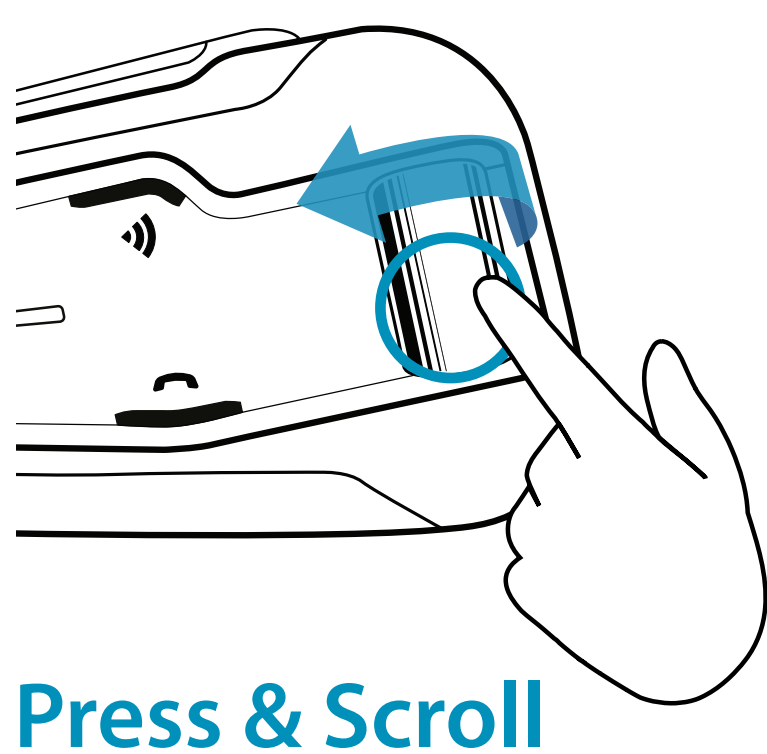

Stop Scan

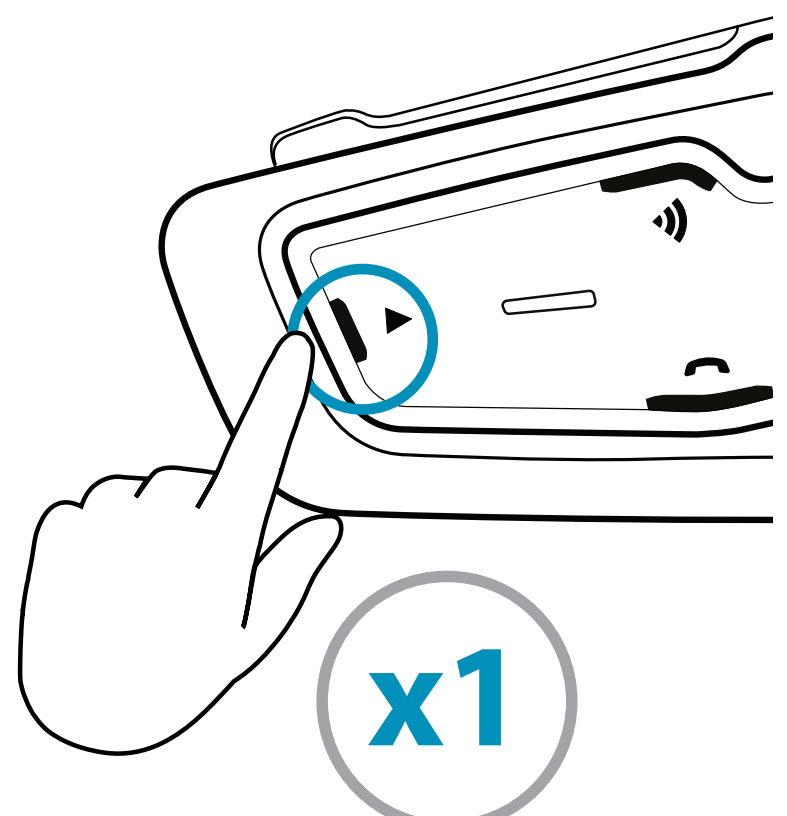

Audio

Music



On

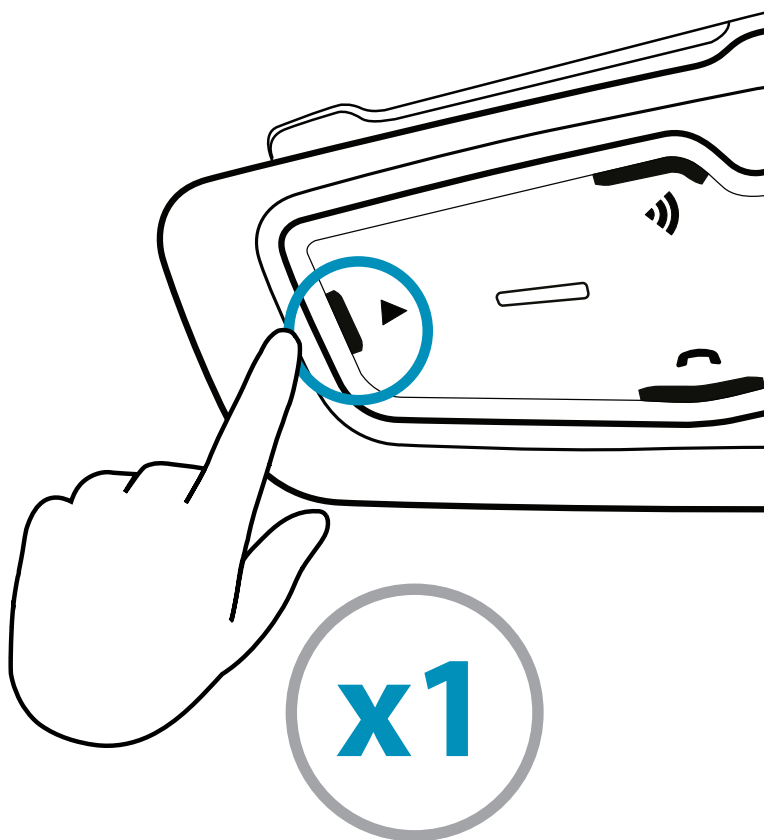

Off

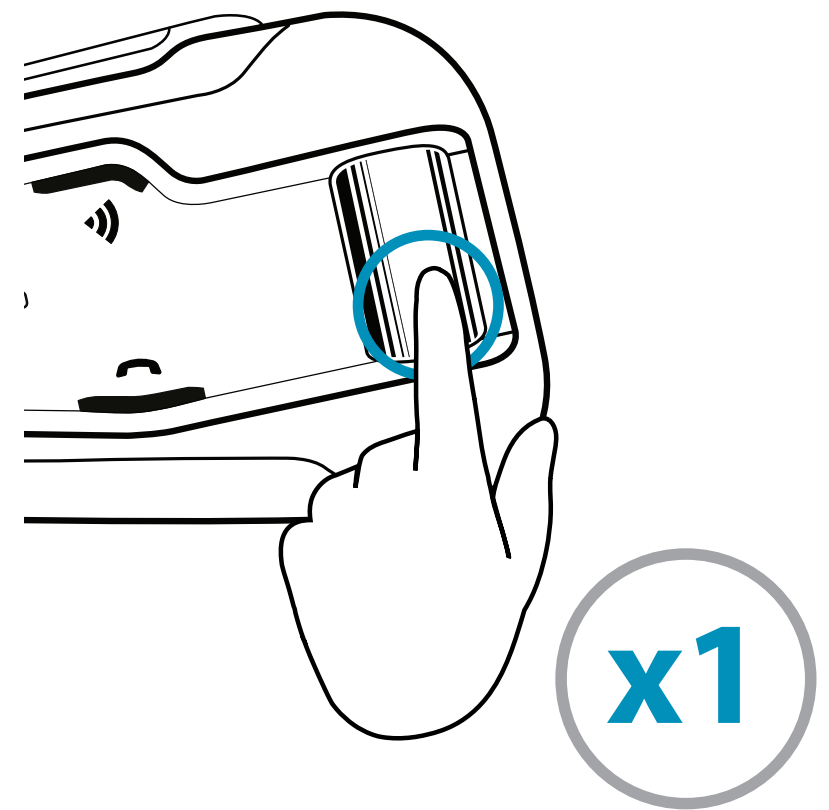

Previous

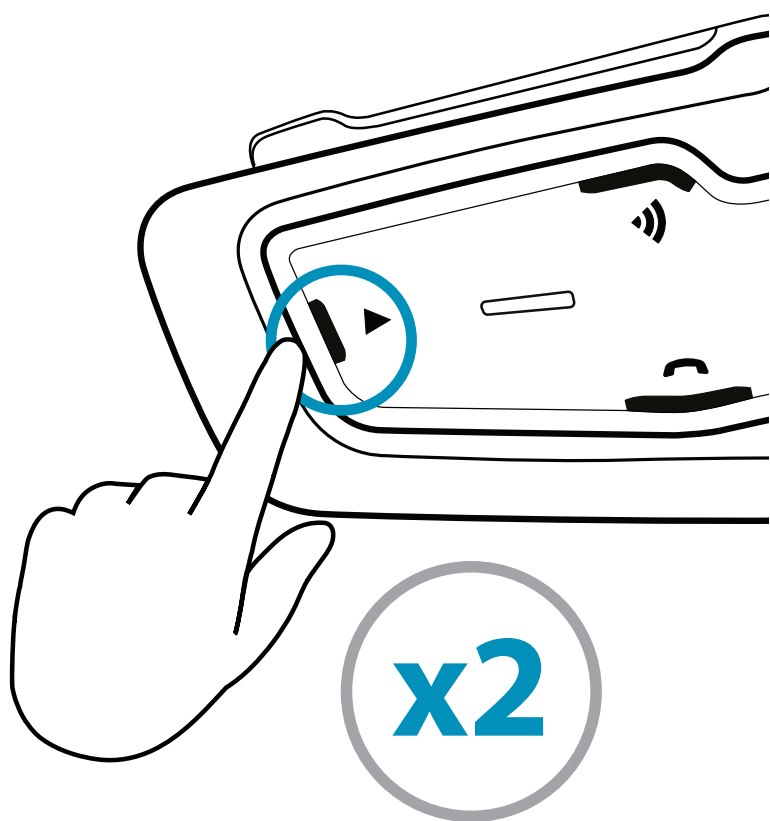

Next

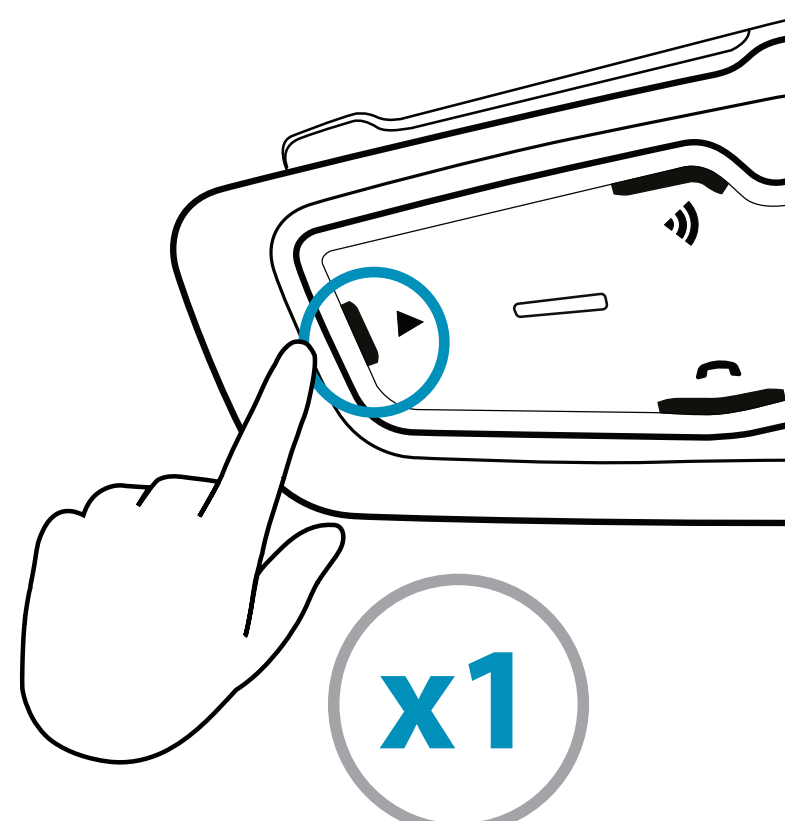

FM/ Music Toggle

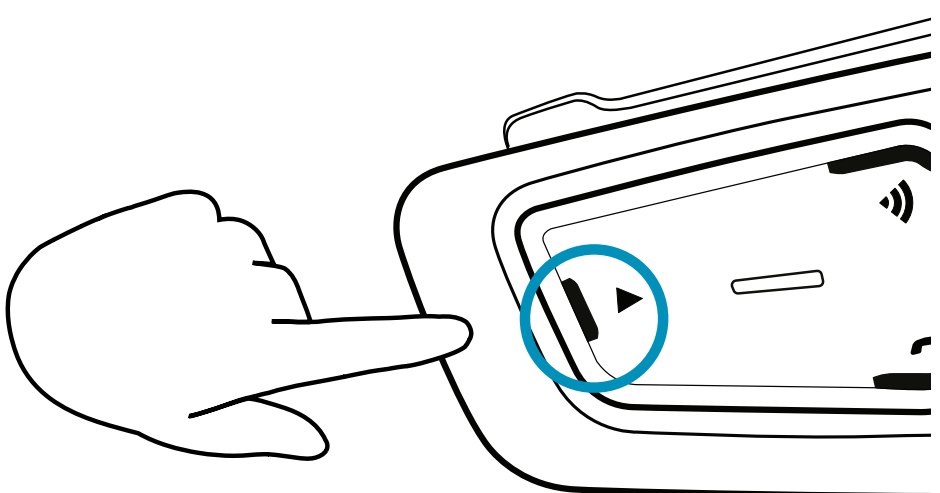

2 Sec.

Sharing Audio

(When in Bluetooth mode)
See opposite page

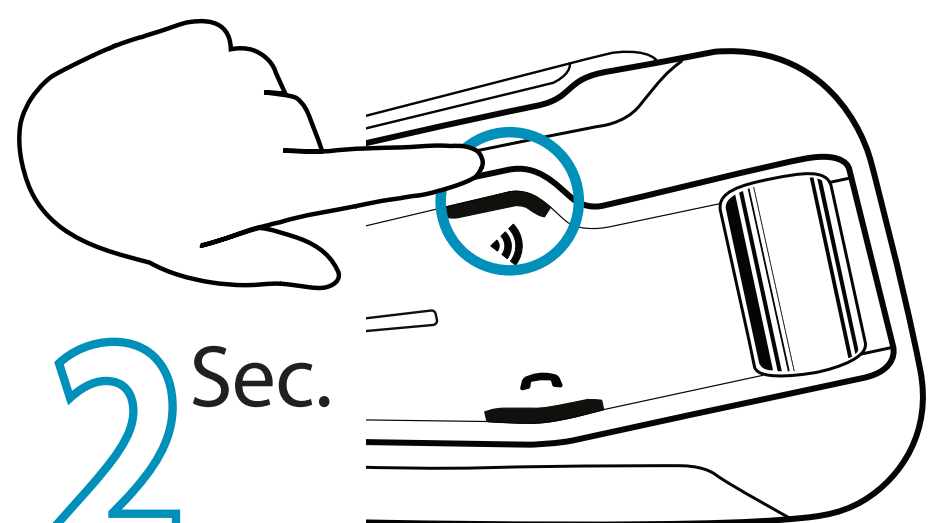

2 Sec.

Start / Stop sharing

DMC Intercom Grouping

Verify you are in  DMC Mode *Flash* 

 **Bluetooth / DMC**
Change Intercom Mode

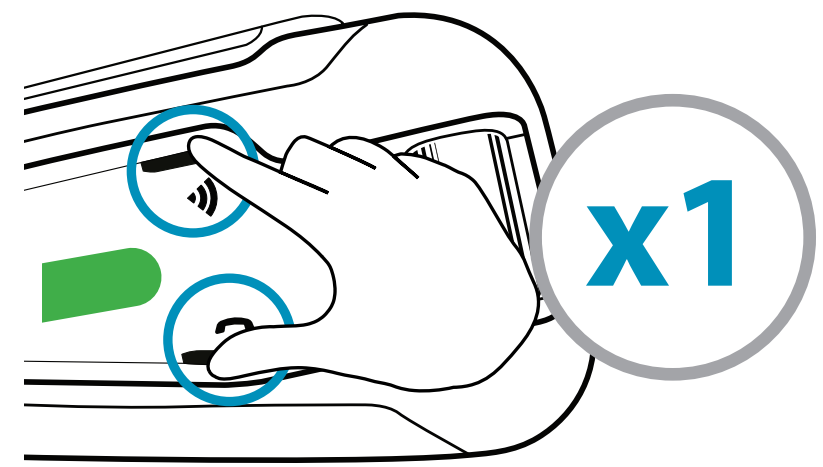

Create / Join a new DMC Group

1 Admin + all group members / new member

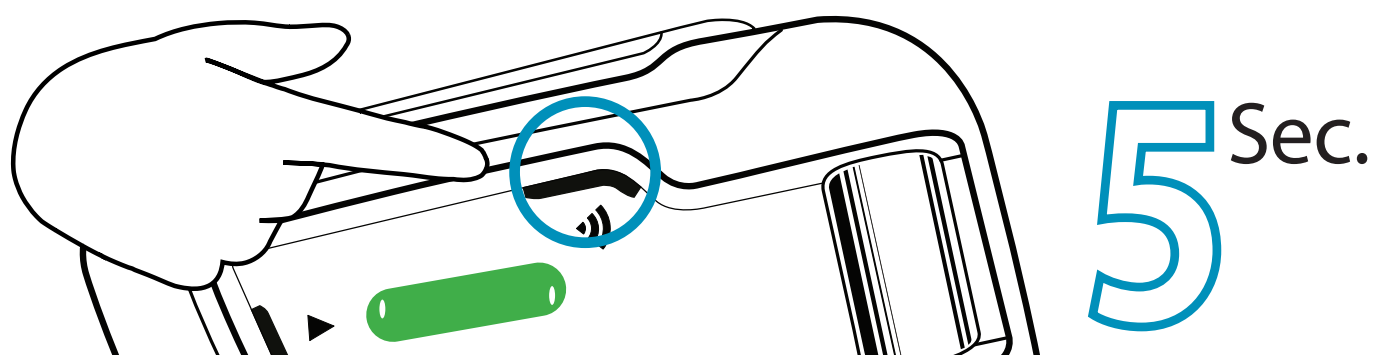

Rapid Flash 

2 **THEN ONLY ONE GROUP ADMIN**

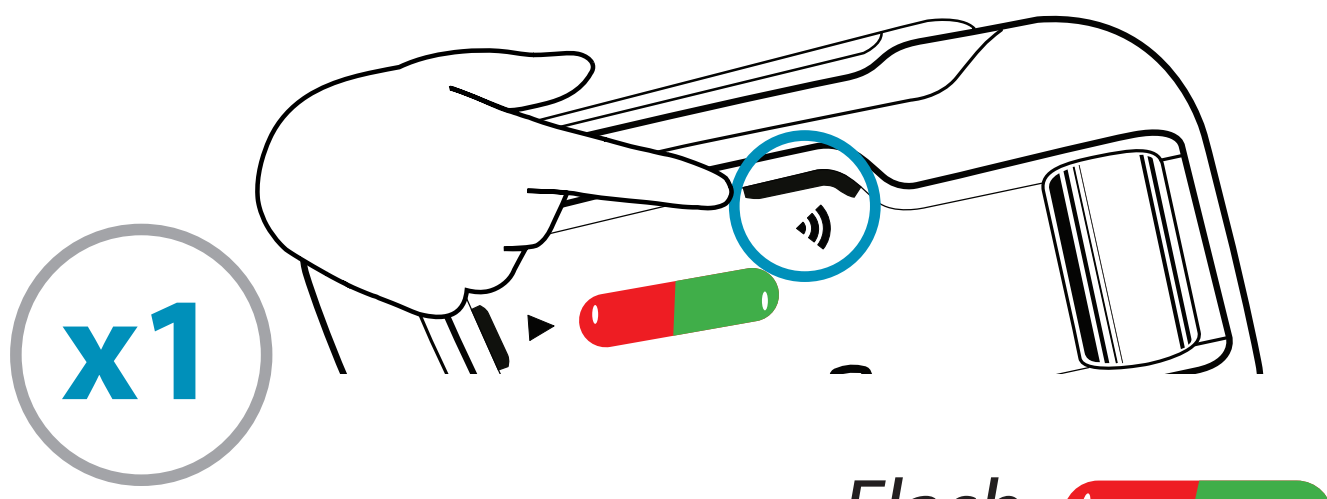

Flash 

Grouped successfully *Flash* 

Cancel Grouping

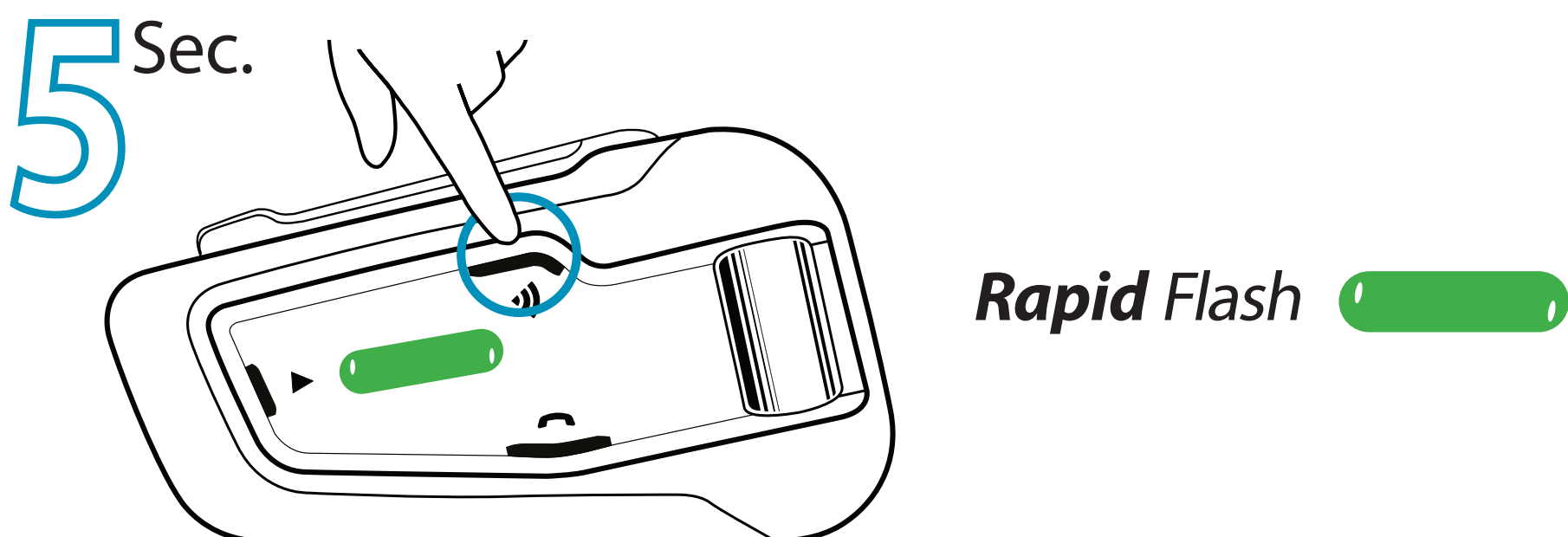

Using DMC Intercom

Talking - always on



Mute Group

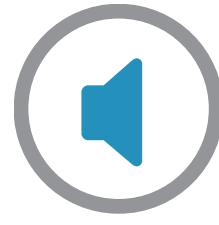

Unmute Group

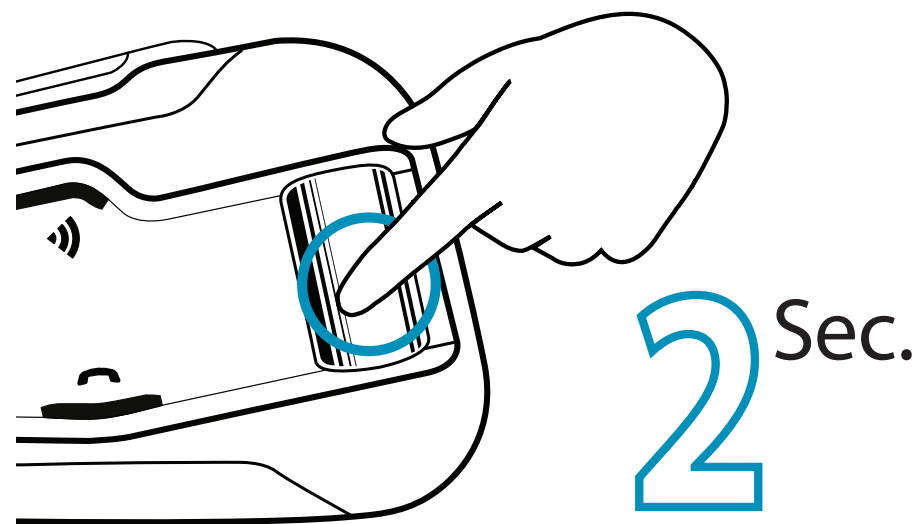

Private Chat

Chat privately with one of the group members

- 1 Choose member for private chat via Mobile App

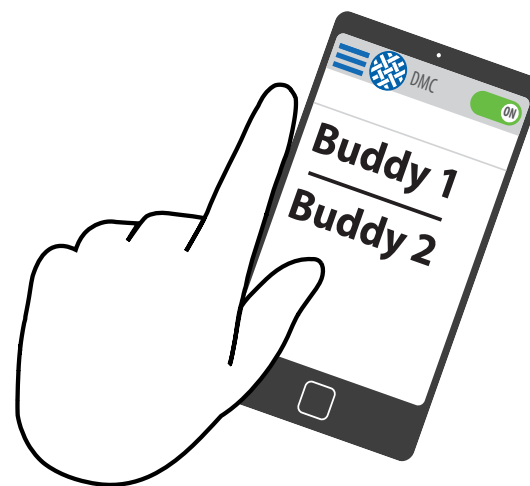

- 2 Start / Stop chat

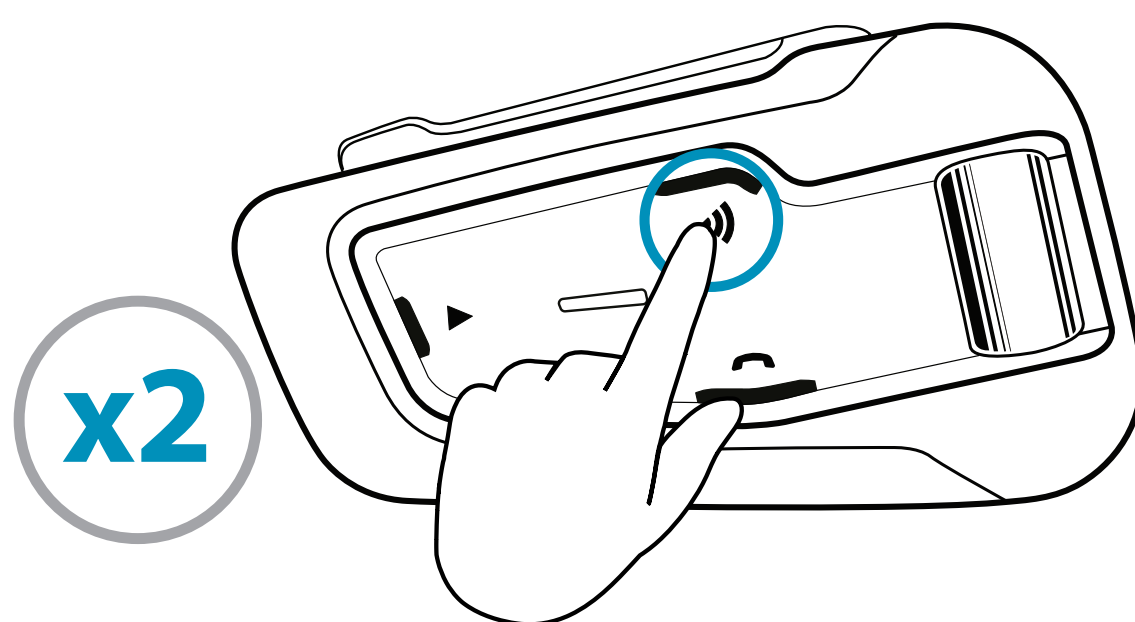

Bridge (add) a non-DMC passenger

- 1 **First**, verify that passenger is paired via Bluetooth. (see 2-way Bluetooth intercom pairing)

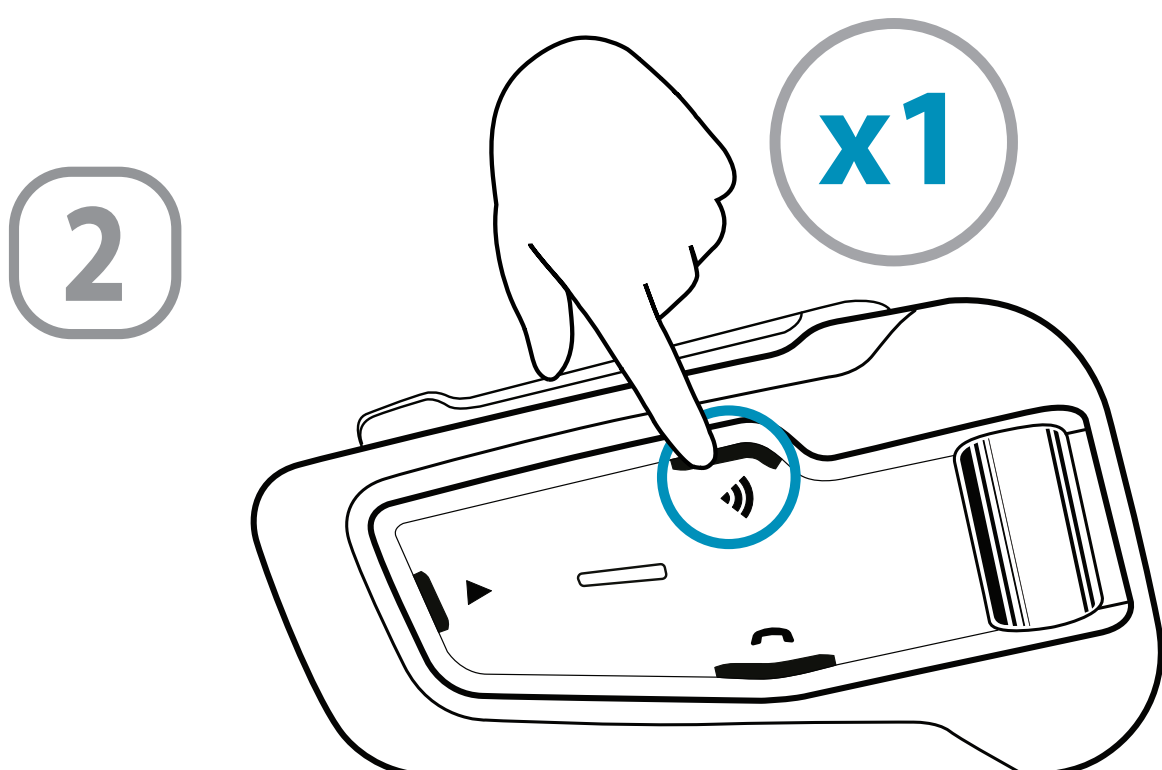

Start / Stop bridging

Set a Cardo non DMC Intercom

Verify you are in  Bluetooth Mode *Flash* 

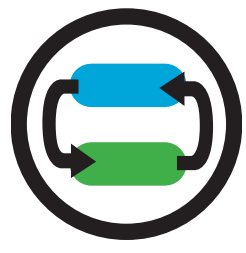

Bluetooth / DMC
Change Intercom Mode

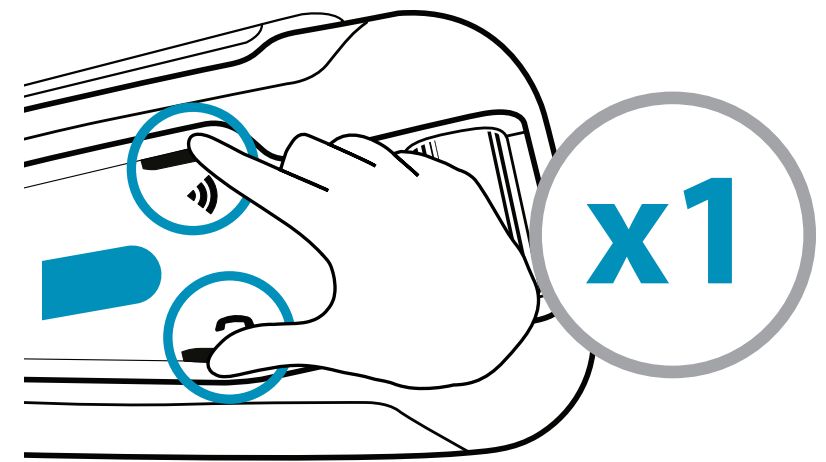

2-way
pairing

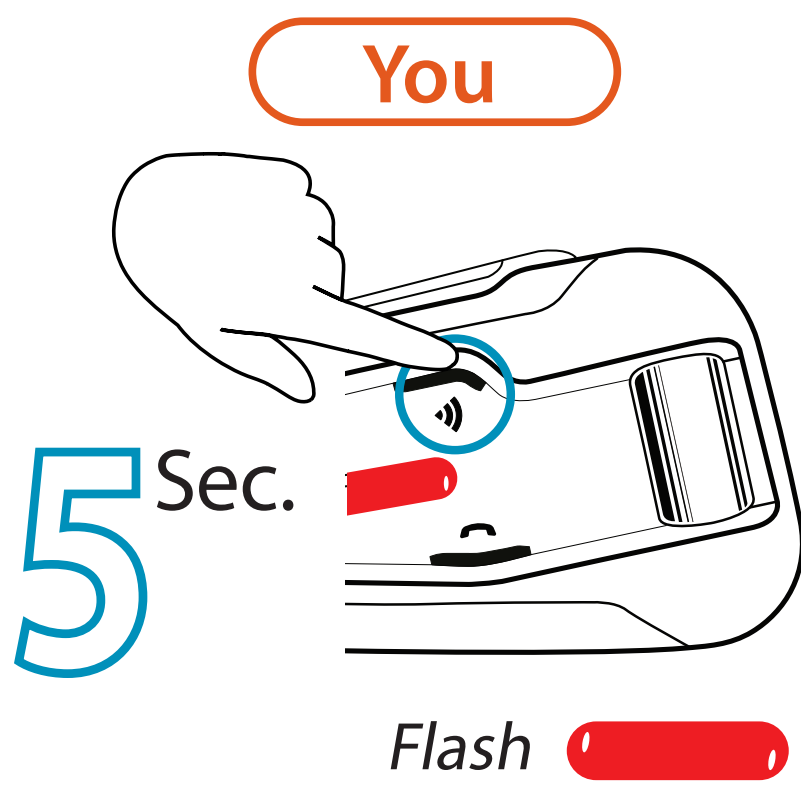

Initiate intercom pairing

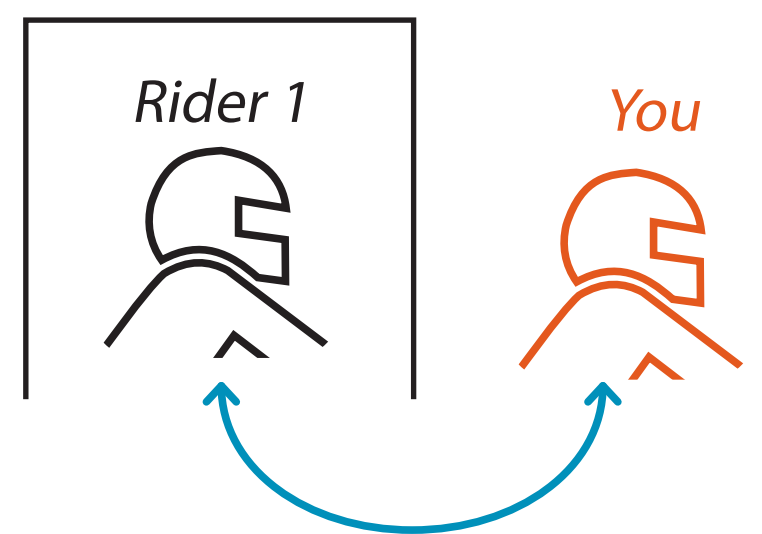

Adding
3rd rider

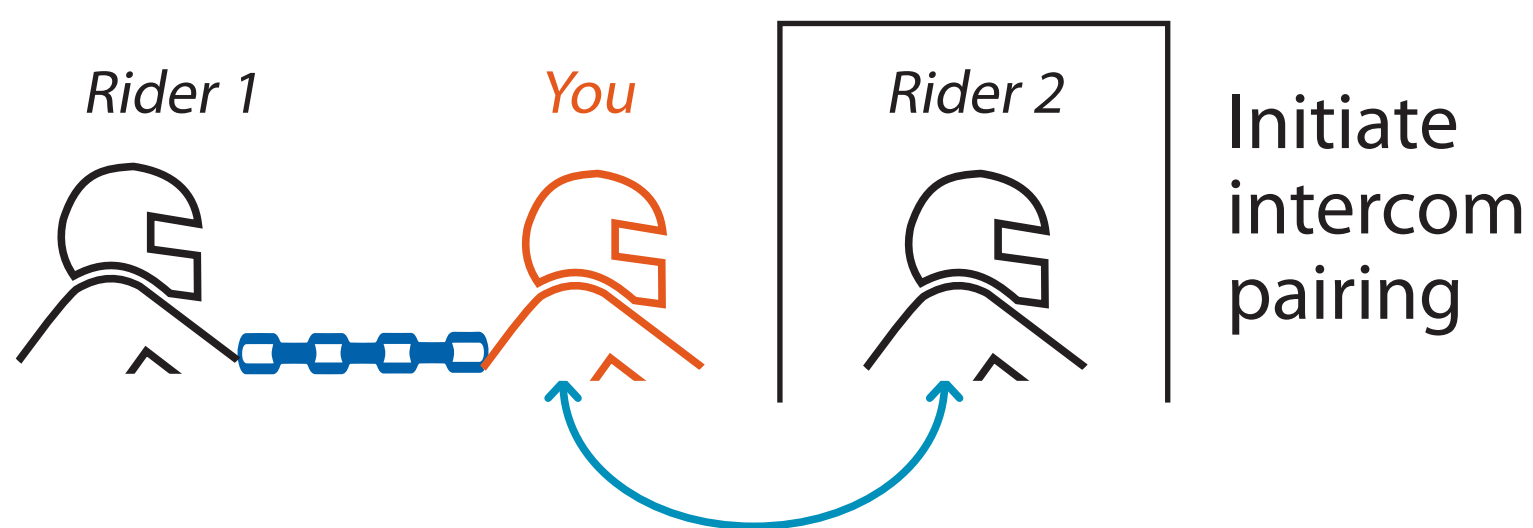
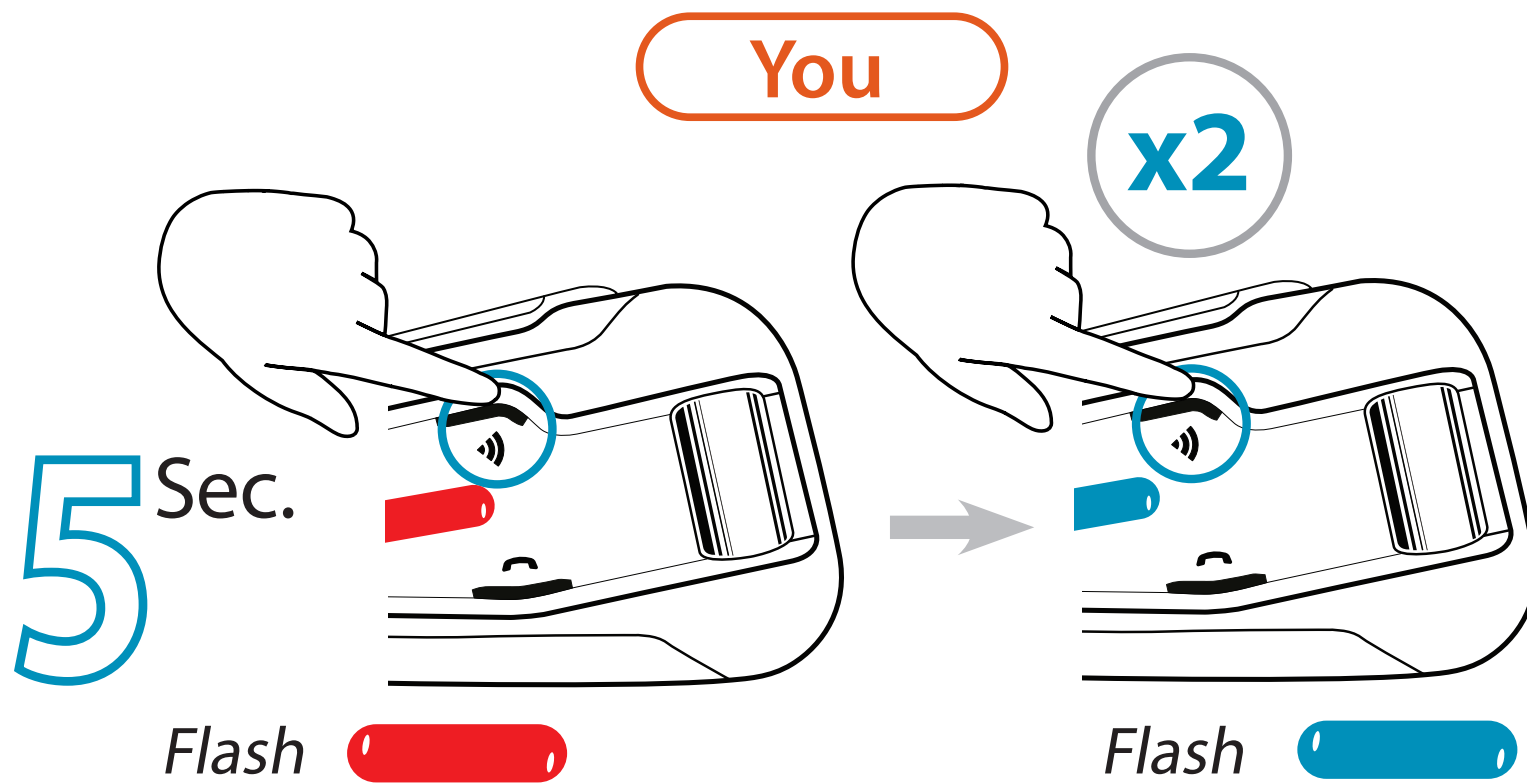

Adding
4th rider

Rider 2 connects to Rider 3
on Rider 2's free channel

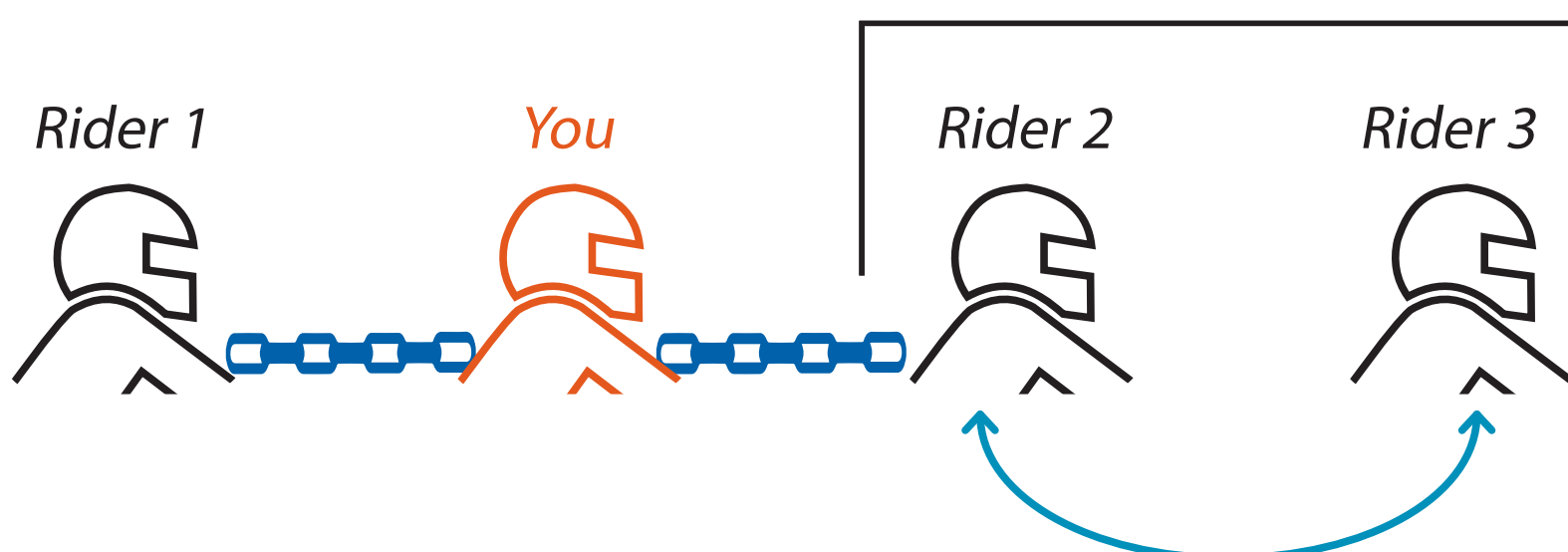

Set a universal intercom

Verify you are in  Bluetooth Mode *Flash* 

 **Bluetooth / DMC**
Change Intercom Mode

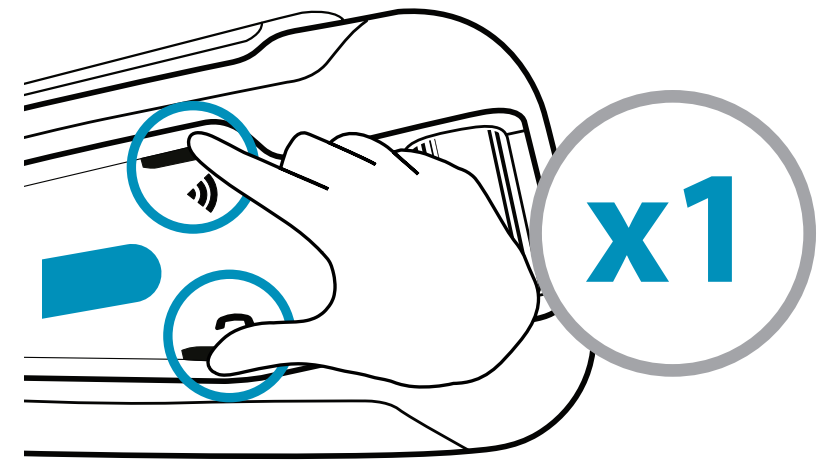

2-way pairing

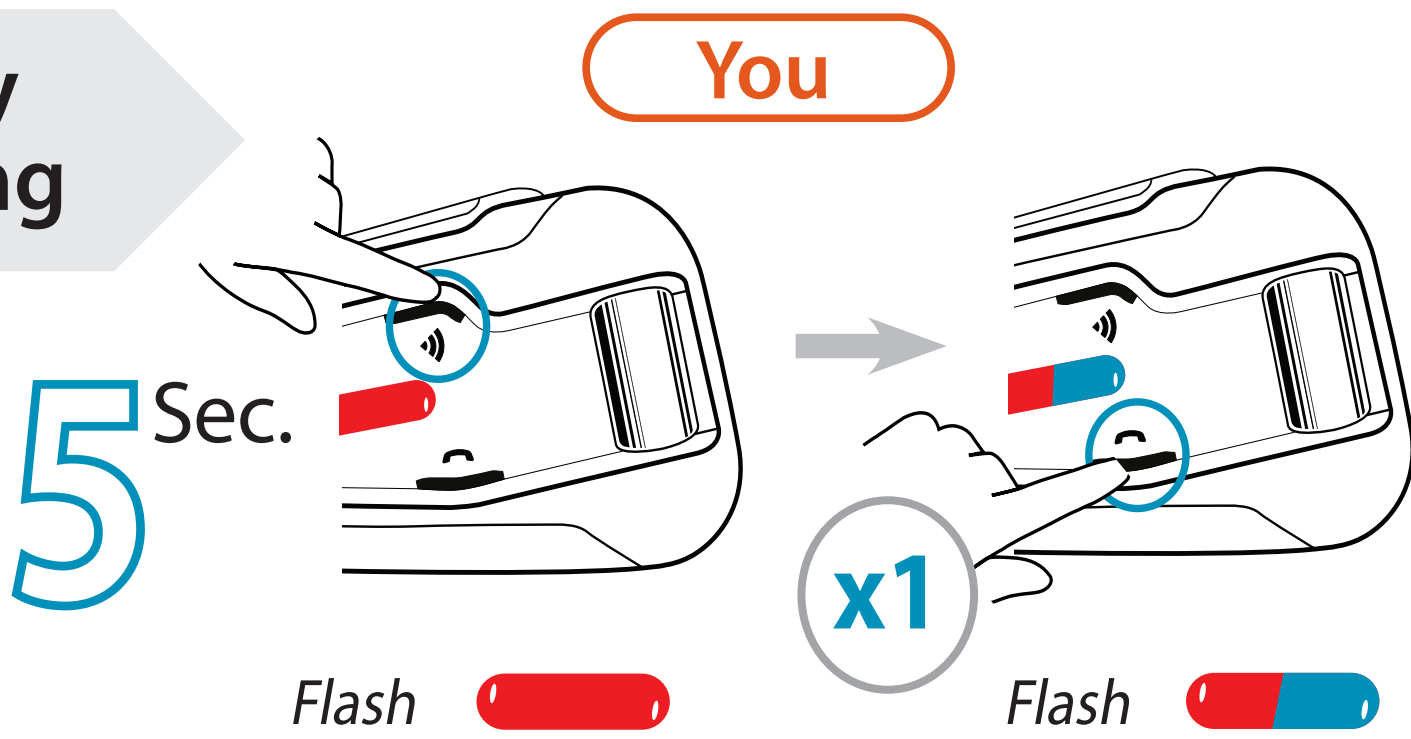

Initiate phone pairing

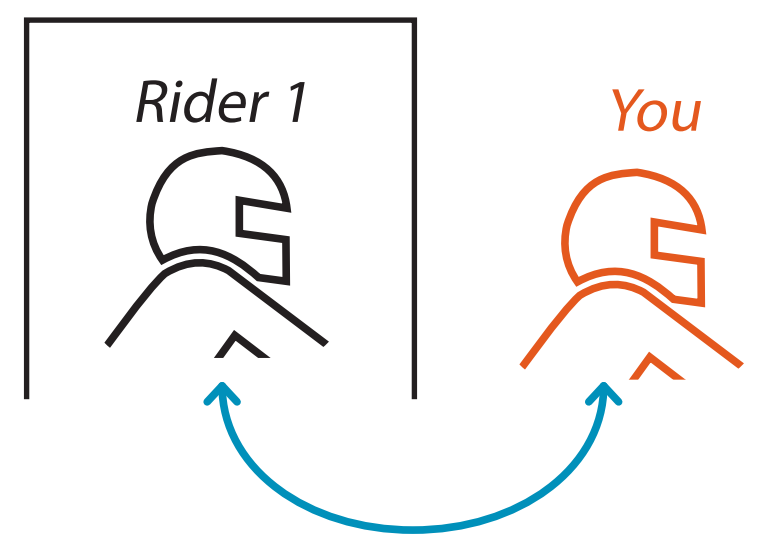

Adding 3rd rider

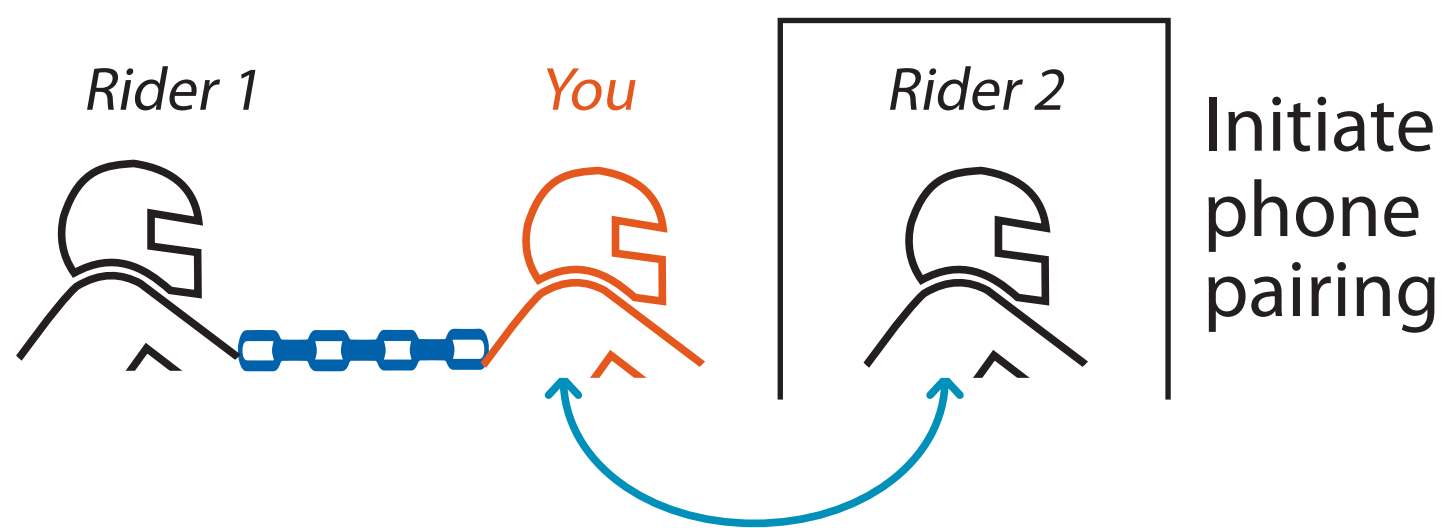
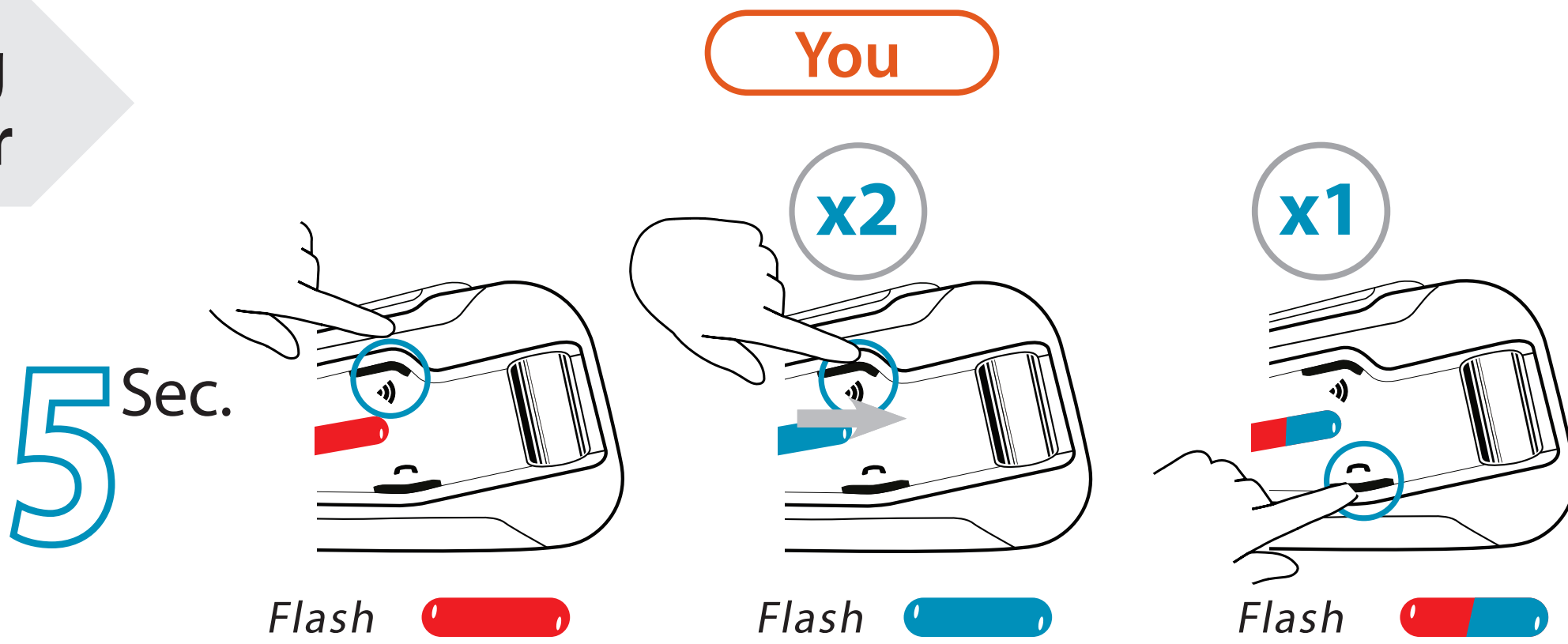

Adding 4th rider

Rider 2 connects to Rider 3 on Rider 2's free channel

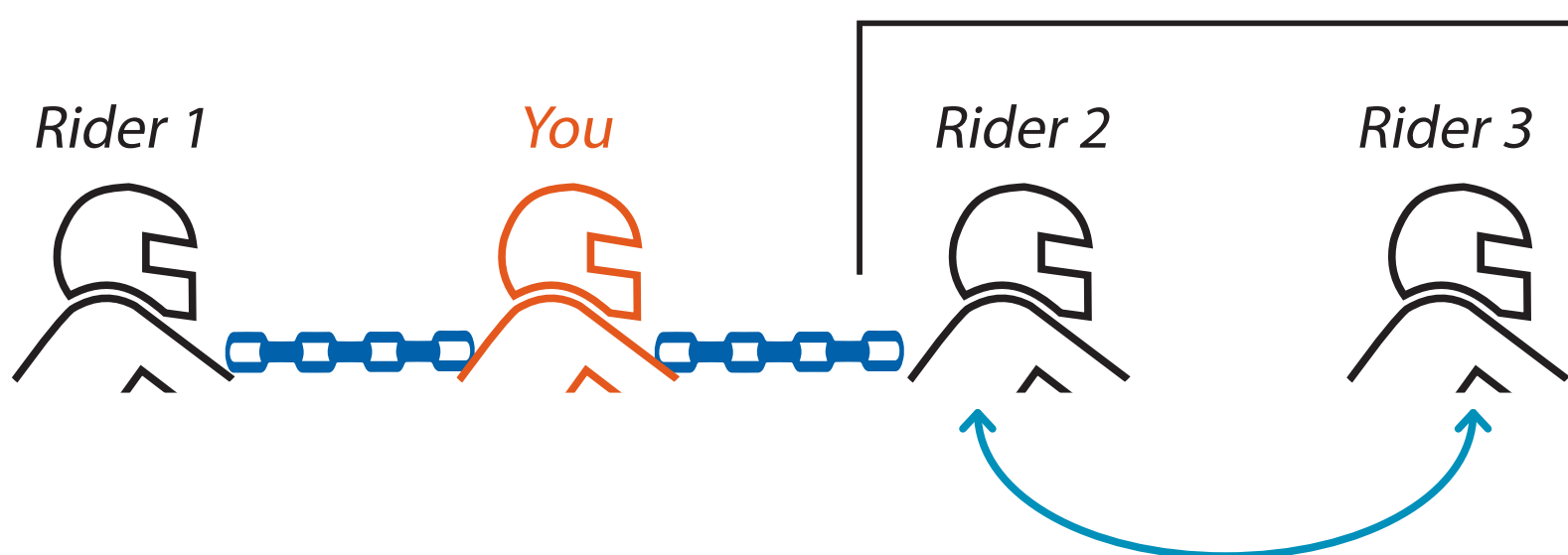

Intercom

  **Start / End / Add Rider 1**

Rider 1

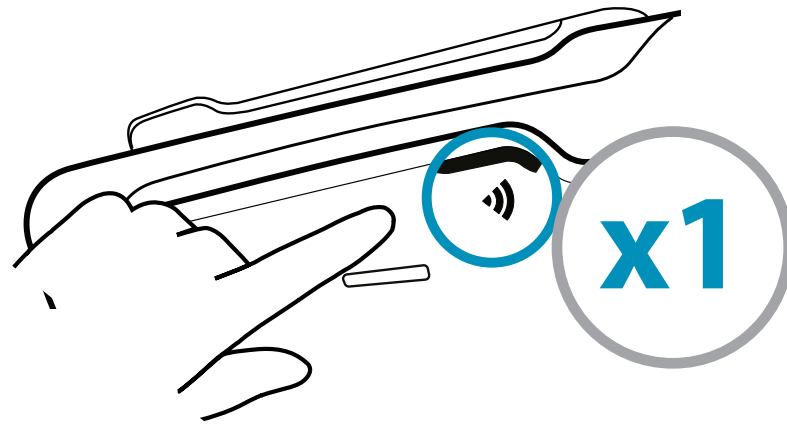

  **Start / End / Add Rider 2**

Rider 2

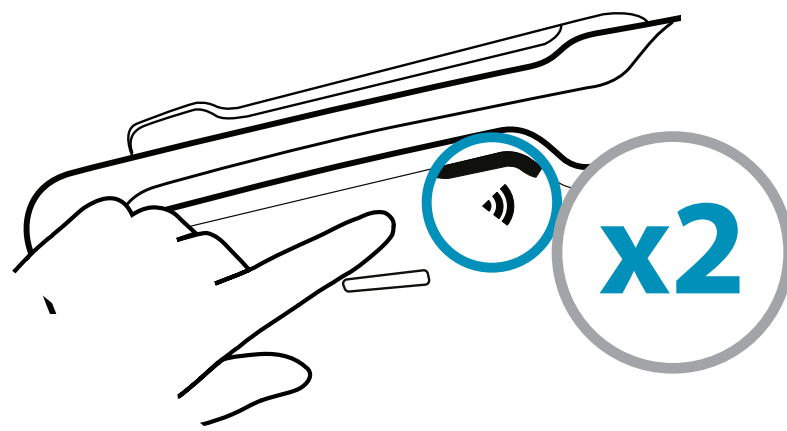

Initiate 4 way intercom Conference

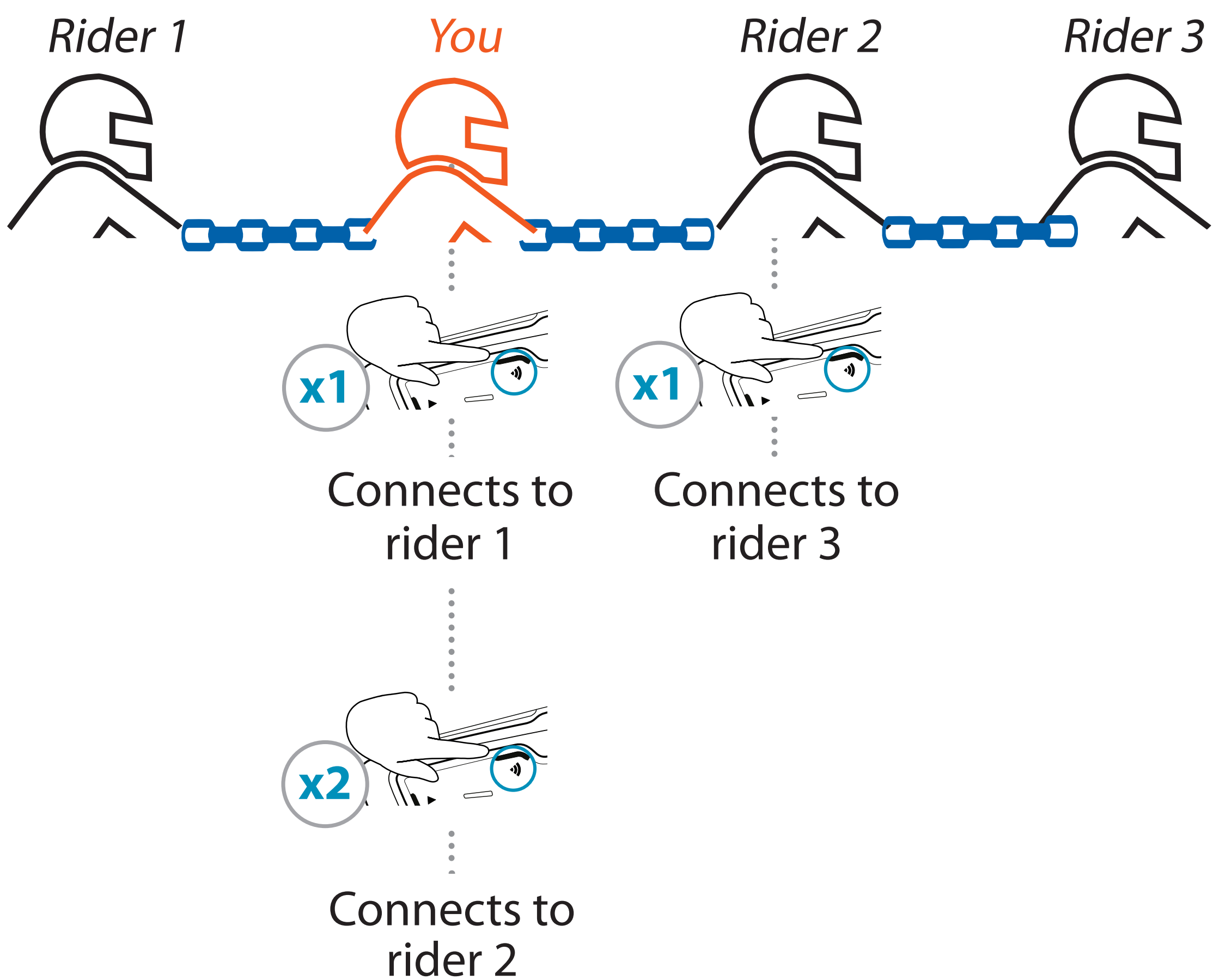

Voice Commands *Always On!*



- "Hey Cardo, **radio on**"
- "Hey Cardo, **radio off**"
- "Hey Cardo, **next station**"
- "Hey Cardo, **previous station**"



- "Hey Cardo, **music on**"
- "Hey Cardo, **music off**"
- "Hey Cardo, **next track**"
- "Hey Cardo, **previous track**"



- "Hey Cardo, **volume up**"
- "Hey Cardo, **volume down**"
- "Hey Cardo, **mute audio**"
- "Hey Cardo, **unmute audio**"



- "Hey Cardo, **speed dial**"
- "Hey Cardo, **redial number**"
- **Answer**
- **Ignore**



- "Hey Siri"
- "Ok Google"



- "Hey Cardo, **battery status**"
- "Hey Cardo, **call intercom**"

Factory Reset

5^{Sec.}

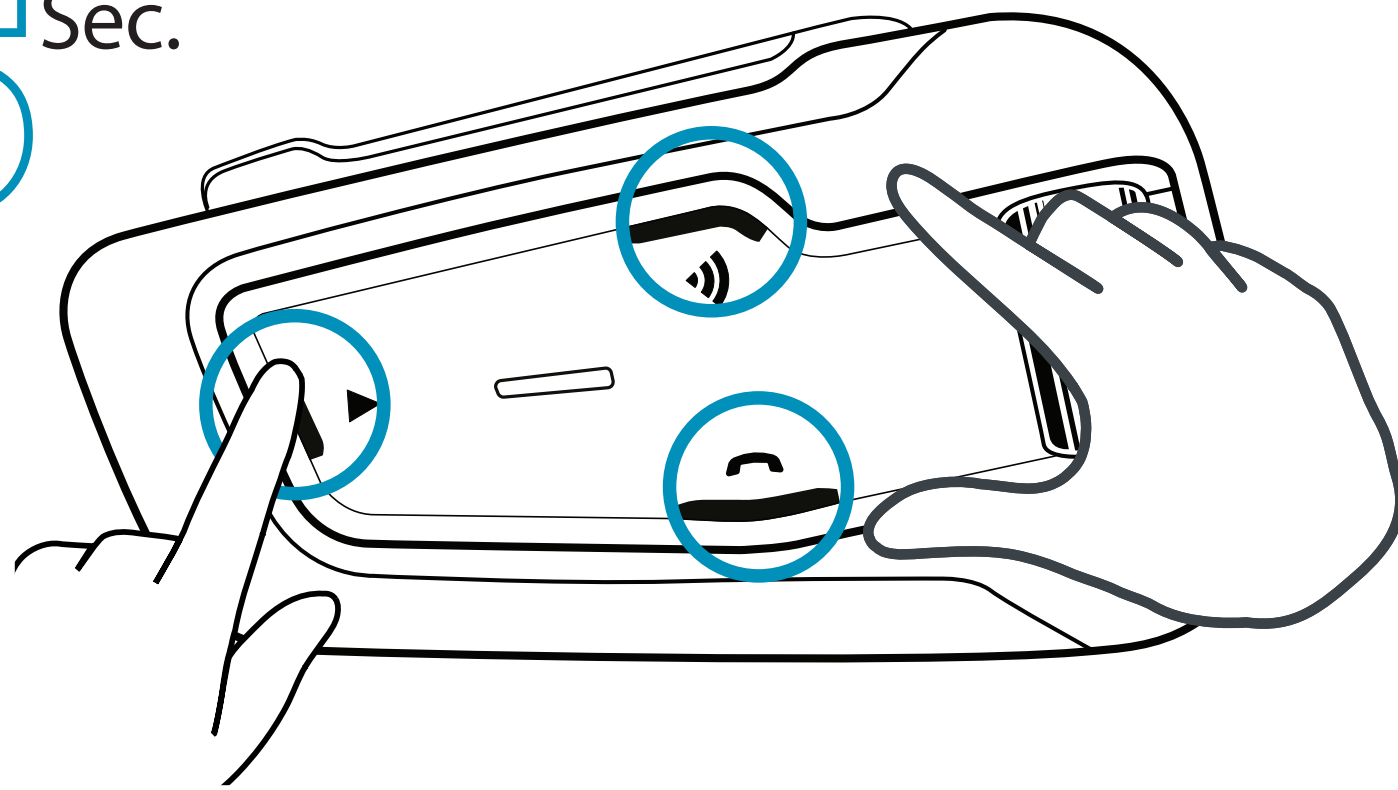

Flash x5:

Cardo Mobile App

- Easy configuration
- Remote control operation
- On-the-go setting customization
- Managing DMC groups

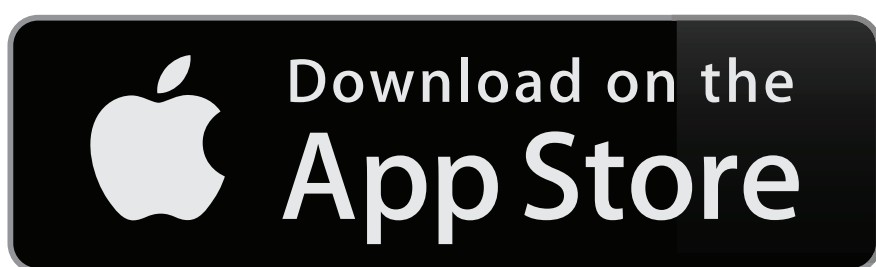

Cardo
Connect
App



Full version of the manual
cardosystems.com/support

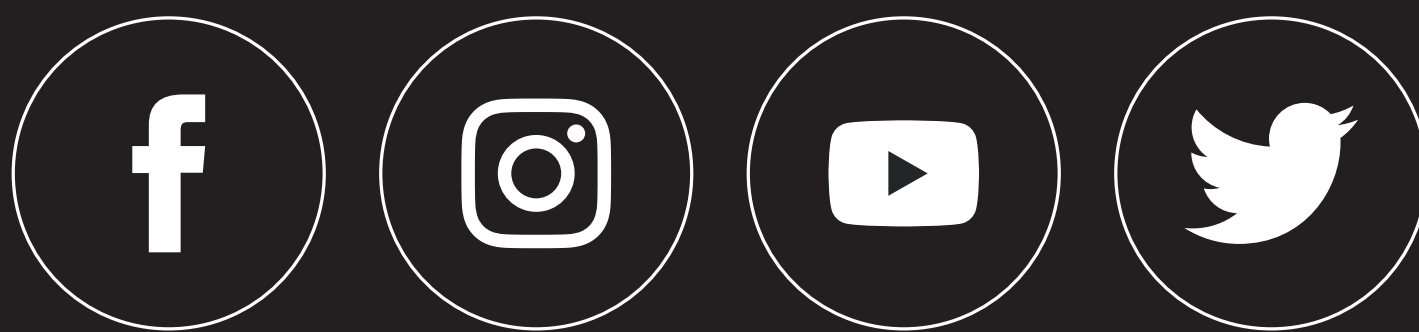

cardosystems.com